



Light is motion

Light range 2017/2018

Global No.1 in Automotive Lighting

Light is OSRAM

OSRAM

Quite simply the best solution

OSRAM provides the perfect vehicle lamp for every use and every requirement, be it in cars, motorcycles, trucks or off-road, be it LED, xenon or halogen, and whether for performance or design-oriented drivers.

Category	Highlight Feature	ECE/Range	Page
Global No.1 in Automotive Lighting			04
New packaging concept			06
LED portfolio overview			10
Xenon portfolio overview			14
Halogen portfolio overview			16
LED			
■ LED headlight	Outstanding design	-	20
■ LED daytime running lights	Increase visibility during the day	-	22
■ LED fog lights	Improving both visibility and style	-	24
■ LED premium & standard retrofits	Wide range of different light colors	-	28
■ LED styling lights	Individual ambiances	-	36
■ LED inspection lights & warning lights	Practical, mobile light sources	-	40
■ LED reading lights	Flexible LED reading light	-	50
Xenon			
OSRAM Trust Program	Verify original OSRAM xenon products	D1S, D1R, D2S, D2R, D3S, D3R, D4S, D4R, D8S	54
■ XENARC® NIGHT BREAKER® UNLIMITED	Brightest OSRAM xenon light	D1S, D2S, D3S, D4S	56
■ XENARC® COOL BLUE® INTENSE	Extra-blue xenon light	D1S, D1R, D2S, D2R, D3S, D4S	58
■ XENARC® ULTRA LIFE	Superior life span and ten-year guarantee ¹⁾	D1S, D2S, D3S, D4S	60
■ XENARC® ORIGINAL	Four-year guarantee ²⁾	D1S, D1R, D2S, D2R, D3S, D3R, D4S, D4R, D8S	62
Halogen Car			
■ NIGHT BREAKER® LASER	Brightest OSRAM halogen light	H4, H7	66
■ NIGHT BREAKER® UNLIMITED	Up to 110% more light ³⁾	H1, H3, H4, H7, H8, H11, HB3, HB4	68
■ SILVERSTAR® 2.0	Best price-performance ratio	H1, H4, H7, H11	70
■ COOL BLUE® INTENSE	Bluish-white light for xenon look	H1, H3, H4, H7, H8, H11, H15, H16, H27W/1, H27W/2, HB3, HB4, HIR2, W5W	72
■ DIADEM® CHROME DIADEM®	Only amber or red during operation	PY21W, WY5W, PR21W, PR21/5W	74
■ ULTRA LIFE	Longer life and four-year guarantee ⁴⁾	H1, H4, H7, H11, P21W, PY21W, P21/5W, W5W, R5W, R10W, C5W, H6W	76
■ ORIGINAL LINE 12V	OEM quality	Complete product range	78
Halogen Motorcycle			
■ NIGHT RACER® 110	Up to 110% more light ³⁾	H4, H7, H8, H11	84
■ NIGHT RACER® 90	Up to 90% more light ³⁾	HS1	84
■ NIGHT RACER® 50	Excellent value for money	H4, H7, H11, HS1	86
■ X-RACER®	Bluish-white light for xenon look	H4, H7, H8, H11, HS1, S2	88
■ ORIGINAL	OEM quality	H4, H7, HS1, S1, S2	88

1) With online product registration. Refer to www.osram.com/am-guarantee for precise conditions and registration

2) Refer to www.osram.com/am-guarantee for precise conditions

3) Compared with standard lamps

4) 4th year with online product registration. Refer to www.osram.com/am-guarantee for precise conditions and registration

Category	Highlight Feature	ECE/Range	Page
Halogen Truck			
■ TRUCKSTAR® PRO	Brightest OSRAM truck light	H1, H3, H4, H7, H11, PY21W, P21W, P21/5W, W5W, R5W, R10W, T4W	92
■ ORIGINAL LINE 24V	OEM quality for trucks	Complete product range	94
Offroad			
■ SUPER BRIGHT PREMIUM			
■ SUPER BRIGHT	Excellent brightness for off-road use	-	98
■ XENARC® COOL BLUE® BOOST			
■ COOL BLUE® BOOST	Hyper blue light for off-road use	-	100
Sets & Tools			
Spare lamp kit for passenger cars			104
Spare lamp kit for trucks and buses			106
Automotive Lamp Cabinet			108
Shelf Rack MINIWATT® assortment box			110
POS product presentation and demonstration			112
Lamp overview			116
Bases			118
Index			120
Summary of types and applications			136
Order information			142

■ = INNOVATION ■ = PERFORMANCE ■ = DESIGN ■ = COMFORT ■ = ORIGINAL

All OSRAM 12 V and 24 V halogen automotive lamps are UV-reduced, can replace existing lamps and meet the relevant standards, e.g. ECE R37 (with the exception of OFF-ROAD lamps)

200 best reasons for OSRAM – the number 1 worldwide

On average, around 200 lamps are fitted in every car – that’s 200 times top quality from OSRAM, the global leader in lighting solutions on and in your vehicle. OSRAM is a leader in innovation and technology, and sells the highest volume of lamps in the fast growing OEM market for cars, as well as in the rapidly expanding market for replacement lamps.



Original brand quality – close to the customer

OSRAM offers OEM quality and by doing so exceeds all ECE minimum standards, since lighting solutions are produced according to the strict requirements of car manufacturers. Workshops and end users can see OSRAM products for themselves at tuning trade fairs and events, and experience innovative product solutions in showcased vehicles.

Certified total quality management “Made in Germany”

The best technicians and engineers are researching and developing right now at several OSRAM locations in Germany. OSRAM is the developmental partner for all leading headlight manufacturers, OSRAM quality management being certified according to ISO 9001 and the vehicle lamps themselves according to TS 16949. Intelligent lighting solutions and uncompromising product quality are only made possible through this certification. This is why OSRAM's customers include the world's foremost automobile manufacturers, and also why OSRAM is one of the best known brands.



The best light for even more vision

The continuous development of vehicle lamps for even better road vision for the driver and sharper perception by other road users is always in the spotlight at OSRAM. Headlamp light of exceptional quality evenly illuminates the field of vision of 50 to 75 metres in front of the vehicle. Many OSRAM headlamps however, illuminate for a significantly greater distance, so that signs, other vehicles and obstacles may be identified even earlier.

Trust through monitoring

Imitations of OSRAM products are not only a commercial problem, but also a safety risk for our customers. The most frequently imitated are OSRAM Xenon products – in order to significantly minimize the number of copies, OSRAM has developed the OSRAM Trust Program, which the customers themselves can use to check whether they have an OSRAM original. More details on page 50/51.



OSRAM – sustainable in principle

Environmental protection at OSRAM goes far beyond compliance with the law: OSRAM production is resource-efficient, is targeted at conserving energy, and reduces packaging material. This is guaranteed consistently and continuously by an environmental management system according to ISO 14001.

OSRAM color code packaging – Go for your perfect match

Just as there are different types of vehicles there are different types of drivers. And there are different reasons for buying vehicle lamps, too. Some drivers always look for the latest innovations, some need optimum performance, others attach importance to design and some prefer long-life products or are simply looking for original spare part quality. Thanks to the new packaging for OSRAM vehicle lamps, luminaires and LED innovations with its clear, comprehensible color coding system all these demands and types of customer are perfectly covered.

INNOVATION

Neutral black and silver color for being innovative and always one step ahead.

PERFORMANCE

Dark and intense red color for “OSRAM Quality” to perfection. Strong, leading, premium.

DESIGN

Cool blue color for creativity, uniqueness and individuality. A color that stands out.

COMFORT

Modern green reflecting the harmonious economist by not being more modern than eco.

ORIGINAL

Bright “OSRAM-Orange” on a white background for trusted quality. Clear association with the brand.

Benefits for your customers

- Less technology-oriented and more customer-oriented communication
- Clear user guidance on the shelf with consistent, cross-product packaging design
- Efficient information provided by modern, clearly understandable icons
- Greater convenience because the right product can be located quickly and easily

Benefits for your lighting business

- Increased sales – bold, attractive design, good visibility on the shelf
- Higher appeal, quality perception and price acceptance – consistently for all products from ORIGINAL SPARE PART to value added products
- Increased consumer acceptance and generation of additional revenue – specially designed “highlights” within the portfolio, rapid recognition of additional products



Get in touch with us and learn more about the new OSRAM packaging concept: www.osram.com/the-perfect-match

Whichever way you look at it: strikingly attractive and informative

The new OSRAM packaging design has a twofold effect: eye-catching from a distance – and clear, persuasive information when seen up close, according to the motto “less is more”.

The front – key information at a glance

The ECE reference, voltage and wattage are shown prominently and clearly in the top left corner as important search criteria. Within the LED portfolio that space is used for highlighting the technology and reference.

The brand name and orange banderole, as a seal of quality, are placed prominently across the top of the packaging.

Instant recognition of the product benefits and added value thanks to large icons that highlight each product’s key values.

The name of the product family is shown clearly.



The vehicle type CAR, MOTORCYCLE, SCOOTER or TRUCK is shown prominently and clearly as an icon in the top right corner.

The level of the upsell is defined by the speedometer. So the number of silver segments on the speedometer changes with the upsell of the value added products to identify the upsell of different products in one product family.

The product is always clearly visible whether as a photo or in a window.

Each segment portrays a vehicle which represents the individual product range to stand out and create recognition. In addition the vehicle type CAR, MOTORCYCLE, SCOOTER, TRUCK underlines the application of the product.

The back – even more information at second glance

Type and order reference.

The added value of the product compared to the standard product is explained in pictograms – comparison of luminous intensity, beam length, light color and service life. Within the LED portfolio that space is used for application notes, technical information or installation advice.



Quality indicator – original spare part in OEM quality.

Clear visualization of product and corresponding application. Always replace in pairs.

Regionally required text and barcode for optimum consumer information. Changes from region to region due to different regional requirements.

Application notes, safety information and mandatory pictograms.

The design shown here for a blister pack is the same for all the other OSRAM Automotive product packaging.

The extended system: also simple and sophisticated

The new attractive packaging concept allows the OSRAM automotive range to be presented in an even more modern, eye-catching and customer-oriented look. New clear color coding based on different “customer types” makes it easy to guide customers to the right product with an effective upsell visualization and a clear differentiation of the various technologies. Of course the new packaging system is not limited to car lamps but also includes motorcycle and truck lamps as well as the latest LED product innovations.

1. Consistent design

New design for all types of packaging

- Folding boxes, blisters – and our new optimized duo boxes

No more color segmentation per vehicle

- Consistent look for all vehicle types within a segmentation
- Image in the speedometer and icon in the top right hand corner according to vehicle
- Customer finds information always in the same place





2. Effective upsell visualization

Differentiation through image and speedometer

- The upsell is visually indicated by a change of the image (more “light beams”) and of the speedometer (more silver colored segments)
- For LED products the color scale of the packaging is also changing

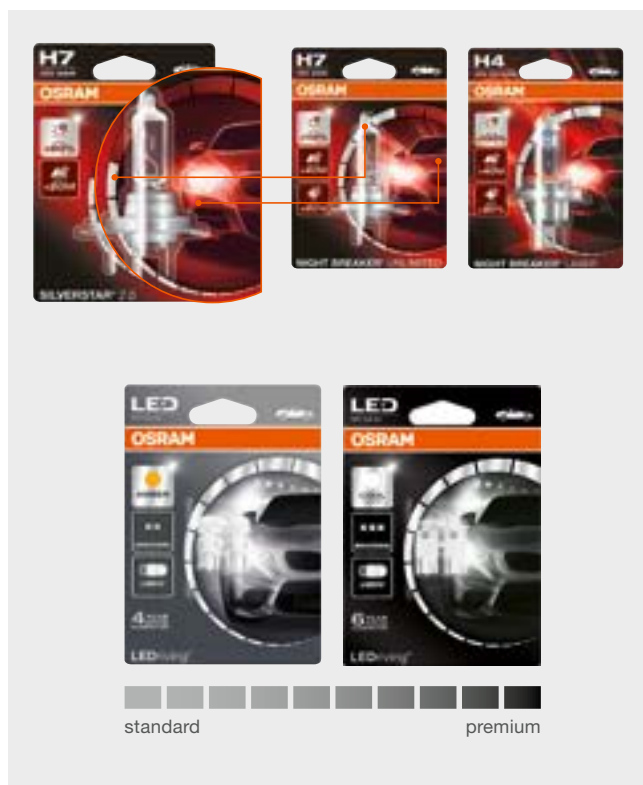

3. Differentiation of xenon and halogen technologies

Xenon products are differentiated by having a silver header showing the technology upsell.



Portfolio overview LED



INNOVATION / LED FIXTURES

LEDDriving® XENARC® GOLF VI headlights



Golf VI redesign made easy – and legal

LEDDriving® XENARC® headlights bring a distinctive look to Golf VI cars, making it possible to upgrade from halogen to xenon headlights with LED daytime running lights and LED indicator lamps.

Range
CHROME, BLACK, GTI

INNOVATION / LED FIXTURES

LEDDriving® daytime running lights



Stylish highlights for state-of-the-art headlights

Innovative, easy-to-install light-guide and pixel solution with high-quality LED technology for low energy consumption and long lifetime: LEDDriving® daytime running lights are the right choice for drivers who want to increase visibility during the day and with an eye for design.

Range
LG, PX-5

INNOVATION / LED FIXTURES

LEDDriving® fog lights



Better sight, better looks

The models in OSRAM's LEDDriving® fog lights series make the switch to new LED fog lights easier than ever: Coming with a range of additional mounting brackets, the fog lights can be configured to suit nearly all types of vehicles.

Range
FOG, FOG PL, FOG F1



INNOVATION / LED RETROFITS

LEDriving® FOG LAMP¹⁾



Light is maximum visibility

The LEDriving® FOG LAMP provides an upgrade with SSL technology with a color temperature of 6000K and perfectly matches existing LED Daytime Running Lights and Xenon Low- and High-beam systems.

Range

PGJ19 (≅H8, H11, H16),
PY20d (≅H10)

INNOVATION / LED RETROFITS

LEDriving® PREMIUM / STANDARD RETROFITS²⁾



Wide range of different light colors

From dome light to foot area, from glove box to trunk, simply replace old lamps with OSRAM's plug-and-play LEDriving® PREMIUM / STANDARD RETROFITS.

Range

W2.1x9.5d (≅W5W, WY5W, W16W),
BA9s (≅T4W), SV8.5-8 (≅C5W)

INNOVATION / LED RETROFITS

LEDriving® PREMIUM / STANDARD RETROFITS¹⁾



Wide range of different light colors

Perfect for a multitude of applications, OSRAM LEDriving® PREMIUM / STANDARD RETROFITS illuminate vehicle exteriors with high color temperatures of up to 6,000 K.

Range

BAY15d (≅P21/5W), BAU15s (≅ PY21W), W2.1x9.5d (≅W5W, WY5W, W16W), W2.5x16q (≅P27/7W-S8W DC), W3x16q (≅W21/5W), BA15s (≅ P21W), W3x16d (≅W21W), BA9s (≅T4W)

1) These products do not have ECE approval. This means they must not be used on public roads

2) INTERIOR ONLY. These products do not have ECE approval. This means they must not be fitted in any exterior automotive application.

Portfolio overview LED



INNOVATION / LED STYLING LIGHTS

LEDambient® CONNECT



Light is pulsating

The LEDambient® CONNECT family offers you to individualize your vehicle's look. Simple to install and run, these innovative LED products use Bluetooth® technology. Once paired to the free LEDambient® CONNECT app you can synchronize your music to up to 10 LEDambient® CONNECT systems to pulse to the same beat.

Range

TUNING LIGHTS Base Kit¹⁾,
TUNING LIGHTS Extension Kit¹⁾,
PULSE CONNECT²⁾,
HYBRID CONNECT²⁾³⁾

INNOVATION / LED STYLING LIGHTS

LEDambient®



Interior ambient lighting

The LEDambient® lights for the interior refresh every car, are attractive and pleasant, and have an appealing contemporary touch. The LED strips are rapidly and easily mounted.

Range

TUNING LIGHTS Base Kit¹⁾,
TUNING LIGHTS Extension Kit¹⁾,
INTERIOR Strip Kit¹⁾

INNOVATION / LED READING LIGHTS

ONYX COPILOT®



Good light for a good ride

ONYX COPILOT® is a flexible LED reading light with pleasantly warm, glare-free light. With its high flexibility, the ONYX COPILOT® light has a wide range of options for illuminating specific areas of the vehicle interior.

Range

COPILOT M, COPILOT L

1) INTERIOR ONLY. These products do not have ECE approval. This means they must not be fitted in any exterior automotive application.



INNOVATION / LED INSPECTION LIGHTS

LEDinspect® PRO**Essential to your garage**

The LEDinspect® PRO inspection lights are especially developed for the complex maintenance and repairs you tackle every day in your garage. Each unique lamp design reflects an understanding of professional applications and supplies light precisely where you need it.

Range

SLIMLINE 280, BONNET 1400, PENLIGHT 150, PENLIGHT 150 UV-A, POCKET 280



INNOVATION / LED INSPECTION LIGHTS

LEDinspect®**Essential to your DIY toolbox**

The rechargeable or ordinary battery-operated LED inspection lights are ideal for use at home. Equipped with durable, high-power LEDs, the luminaires provide optimum illumination for even the tightest spaces and difficult-to-access locations.

Range

FOLDABLE 80, MINI 125, PENLIGHT 80, POCKET 160, FLASHLIGHT 15, SLIMLINE 250, PROFESSIONAL 150, HEADLAMP 300



INNOVATION / LED WARNING LIGHTS

LEDguardian®**Prepared for serious situations**

OSRAM LEDguardian® warning lights are the ideal LED accessory for drivers who want to be equipped for any situation on the road.

Range

SAVER LIGHT PLUS, ROAD FLARE

2) These products do not have ECE approval. This means they must not be used on public roads. Please note: Use on public roads leads to cancellation of operating license and loss of insurance coverage. Products not for sale in Germany.

3) Do not use while driving

Portfolio overview xenon



PERFORMANCE

XENARC® NIGHT BREAKER® UNLIMITED
Up to +70% LIGHT

DESIGN

XENARC® COOL BLUE® INTENSE
XENONEXTRA BLUE

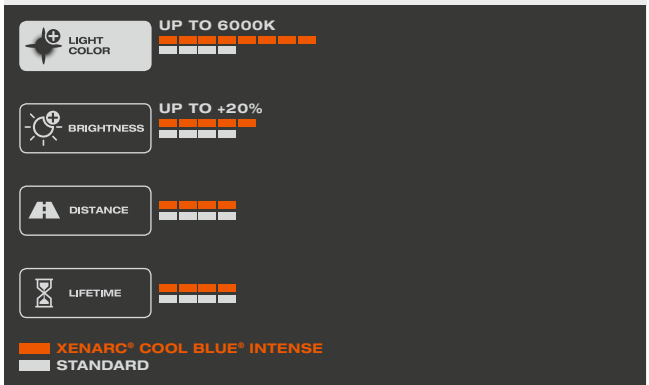
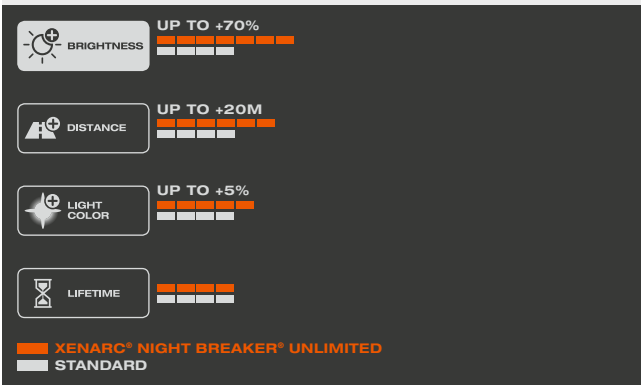

ECE/Range
 D1S, D2S, D3S, D4S

ECE/Range
 D1S, D1R, D2S, D2R, D3S, D4S



COMFORT

XENARC® ULTRA LIFE
10 YEAR OSRAM GUARANTEE¹⁾



ORIGINAL

XENARC® ORIGINAL
ORIGINAL SPARE PART

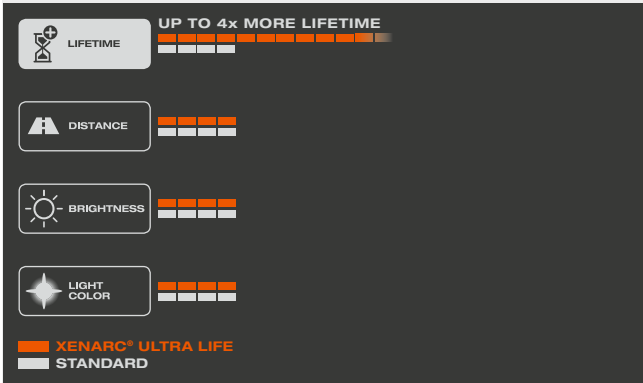

ECE/Range
 D1S, D2S, D3S, D4S

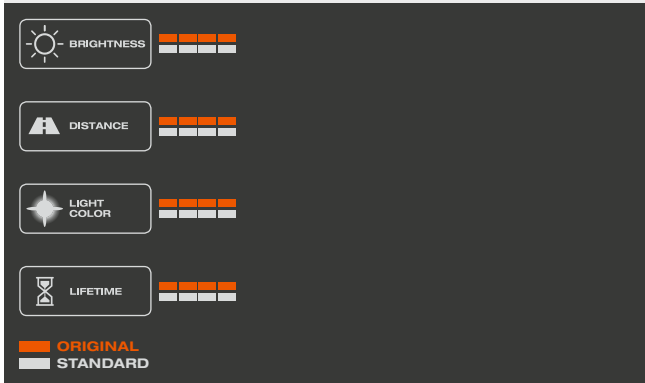

ECE/Range
 D1S, D1R, D2S, D2R, D3S, D3R, D4S, D4R, D8S

1) With online product registration. Refer to www.osram.com/am-guarantee for precise conditions and registration

Portfolio overview halogen



PERFORMANCE

NIGHT BREAKER® LASER

Up to +130% LIGHT

PERFORMANCE

NIGHT BREAKER® UNLIMITED

Up to +110% LIGHT

PERFORMANCE

SILVERSTAR® 2.0

Up to +60% LIGHT

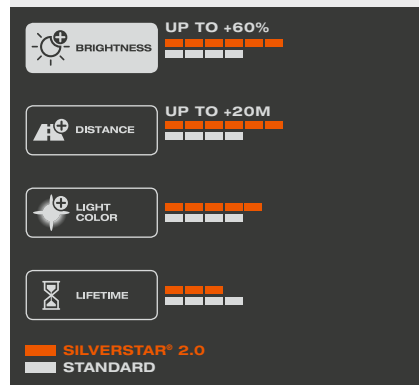
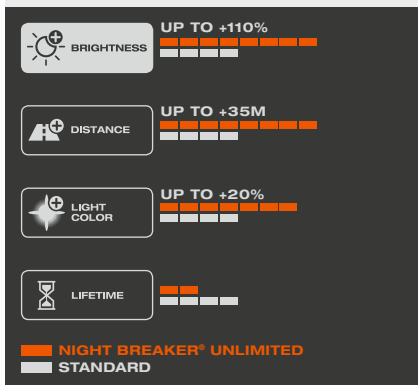
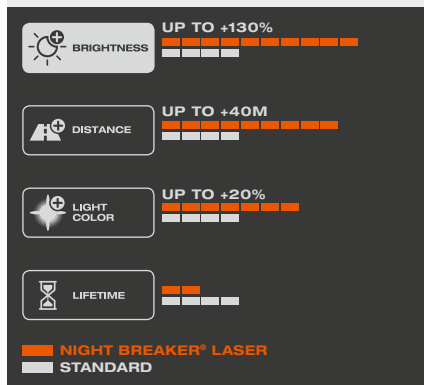

ECE/Range
H4, H7

ECE/Range
H1, H3, H4, H7, H8, H11, HB3, HB4

ECE/Range
H1, H4, H7, H11



DESIGN

COOL BLUE® INTENSE

XENON LOOK



COMFORT

ULTRA LIFE

4 YEAR OSRAM GUARANTEE¹⁾



ORIGINAL

ORIGINAL

SPARE PART

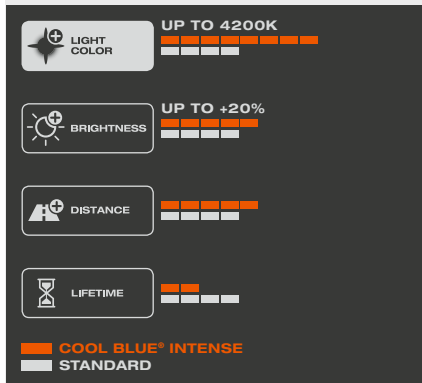

ECE/Range
 H1, H3, H4, H7, H8, H11, H15, H16, H27W/1, H27W/2, HB3, HB4, HIR2, W5W

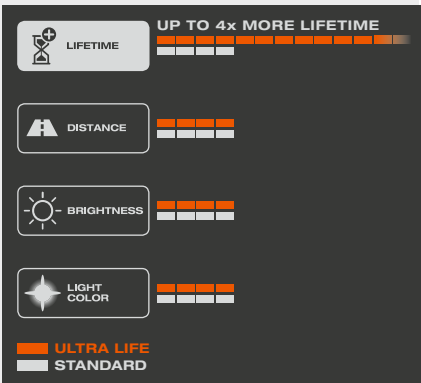

ECE/Range
 H1, H4, H7, H11, P21W, PY21W, P21/5W, W5W, R5W, R10W, C5W, H6W, HY21W

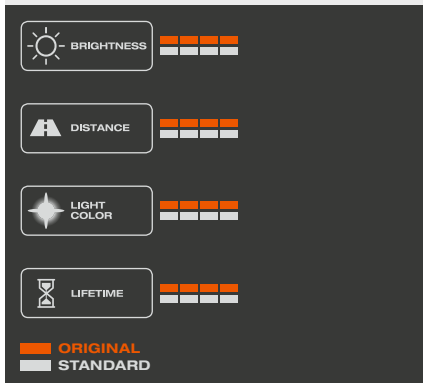

ECE/Range
 Complete Product Range

1) 4th year with online product registration. Refer to www.osram.com/am-guarantee for precise conditions and registration

LEDs in the vehicle – versatile, stylish, individual

The range of versatile and innovative OSRAM LED products is wide and individual, since they allow anyone to create their own personal lighting ambience in a vehicle with attractive color schemes, some controllable via app. In addition to these customisation options, OSRAM offers an extensive range of accessories such as inspection lights and stylish reading lights for the vehicle interior, as well as retrofittable fog lights and daytime running lights.



LEDDriving® XENARC® headlight

Golf VI redesign made easy – and legal

With its outstanding design, the LEDDriving® XENARC® headlight combines modern LED daytime running light functionality with a powerful xenon lamp. With this headlight, OSRAM offers a solution for all Golf VI models not equipped with xenon headlights. Upgrading to the ECE-approved LEDDriving® XENARC® headlight complies with all legal requirements – no need to fit automatic leveling or a headlight-cleaning system.



LEDDriving® XENARC® Golf VI GTI Edition
(LEDHL102-GTI)

Main benefits

- Two-year guarantee¹⁾
- Pixel-free optic thanks to state-of-the-art lightguide technology
- Up to 70% more light²⁾
- Up to 20 m longer light cone²⁾
- Up to 40% whiter light²⁾
- No additional beam level adjustment and headlight cleaning system required
- Easy plug and play installation without modifying or damaging existing cables
- No additional parts needed for installation
- No additional registration needed (ECE certified)
- Available as GTI, BLACK and CHROME edition

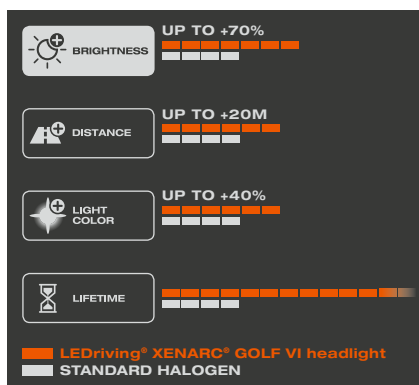



OSRAM LEDDriving® XENARC® Golf VI Edition headlight product range

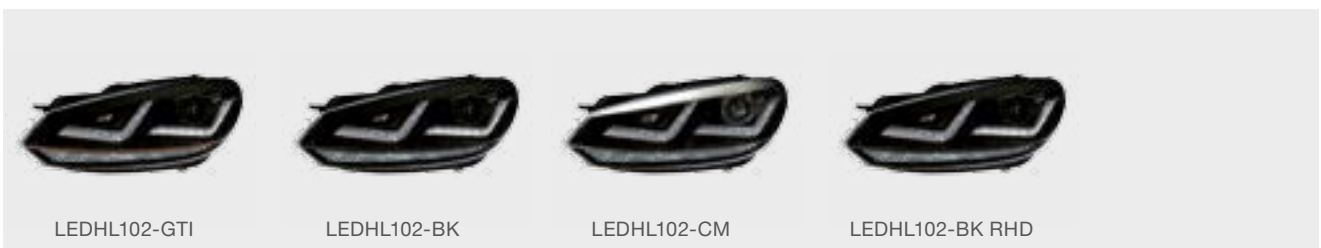

Product Reference	Product Number	V	W	K	l (mm)	w (mm)	h (mm)			No.
LEDHL102-GTI ^(3,4)	4052899982161	12	70	-	410	450	200	1	1	-
LEDHL102-BK ^(3,4)	4052899982123	12	70	-	410	450	200	1	1	-
LEDHL102-CM ^(3,4)	4052899982147	12	70	-	410	450	200	1	1	-
LEDHL102-BK RHD ^(4,5)	4052899519442	12	70	-	410	450	200	1	1	-



Daytime Running Light



Position Light and Low Beam



Position Light and High Beam



Position Light and Signal Light (Dynamic/Static)

- 1) Refer to www.osram.com/am-guarantee for precise conditions
- 2) When compared to standard headlights with halogen lamp
- 3) Not suitable for left-hand traffic
- 4) Only suitable for Golf VI cars with OEM halogen headlight
- 5) Suitable for left-hand traffic



OSRAM LEDriving[®] daytime running lights

Stylish highlights for state-of-the-art headlights

Innovative, easy-to-install lightguide and pixel solution with high-quality LED technology for low energy consumption and long lifetime: LEDriving[®] daytime running lights are the right choice for drivers who want to increase visibility during the day and with an eye for design.

Main benefits of LG (LEDDRL102)

- Five-year guarantee¹⁾
- LED daytime running light including position light
- Pixel-free brilliance and dynamic curves
- Color temperatures of up to 6,000 K
- Long lifetime of up to 5,000 h
- Dimmable
- Low energy consumption
- Simple installation
- OEM technology
- Compatible with start-stop system and hybrid vehicles

Main benefits of PX-5 (LEDDRL301 CL15)

- Three-year guarantee¹⁾
- Dynamic appearance thanks to faceted optic and dotted pixel technology
- Color temperatures of up to 5,200 K
- Simple installation



OSRAM LEDDriving® daytime running light product range

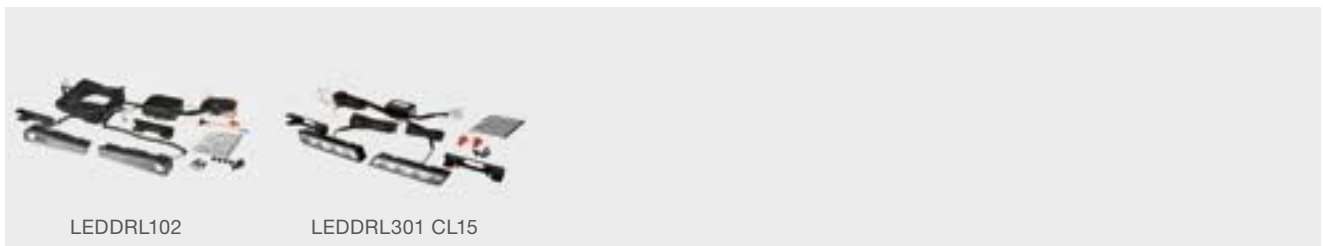

Product Reference	Product Number	V	W	K	$\frac{l}{\text{[mm]}}$ ³⁾	$\frac{w}{\text{[mm]}}$ ³⁾	$\frac{h}{\text{[mm]}}$ ³⁾			No.
LEDDR102 ²⁾	4052899 200494	12	15	6.000	167	42	31	1	4	-
LEDDR301 CL15 ²⁾	4052899 170766	12	13.5	5.200	160	30	23	1	5	-

1) Refer to www.osram.com/am-guarantee for precise conditions

2) Compatible with start-stop system and hybrid vehicles

3) Product measurements



OSRAM LEDriving[®] fog lights

Better sight, better looks

LEDriving[®] fog lights offer brilliant LED options for tuning and technology fans. Improving both visibility and style, they perfectly complement one's headlights. Additional mounting brackets to install LEDriving[®] fog lights to different car models are available.

Main benefits of FOG¹⁾ (LEDFOG101)

- Five-year guarantee²⁾
- LED fog light with daytime running light functionality
- Lens resistant to gravel impact according to ASTM D256 and ISO 179
- Automatic operation thanks to intelligent control
- Color temperatures of up to 6,000 K
- Long lifetime of up to 5,000 h
- Low energy consumption
- Simple installation
- Suitable for 12 V and 24 V onboard power supply systems
- OEM technology

Main benefits of mounting bracket

- Two-year guarantee²⁾
- Available for: Toyota, Volkswagen, Nissan and Infiniti car models
- Fits most car models with 90-mm fog lights



Check the compability of your car!
Vehicle Finder: www.osram.com/fog-finder



OSRAM LEDDriving® FOG

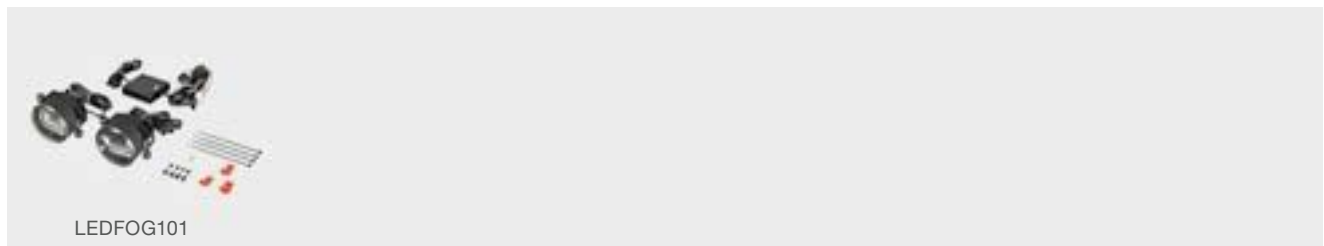

Product Reference	Product Number	V	W	K	$\frac{l}{(mm)}$ ³⁾	$\frac{w}{(mm)}$ ³⁾	$\frac{h}{(mm)}$ ³⁾			
LEDFOG101	4008321890566	12/24	7/12	6.000	114	97.5	90	1	4	-

OSRAM LEDDriving® mounting bracket product range



Product Reference	Product Number	V	W	K	$\frac{l}{(mm)}$ ³⁾	$\frac{w}{(mm)}$ ³⁾	$\frac{h}{(mm)}$ ³⁾			
LEDFOG101-TY-M	4052899094550	-	-	-	120	102	54	1	4	-
LEDFOG101-VW-M	4052899274495	-	-	-	103	66.5	94	1	4	-
LEDFOG101-NIS-M	4052899274518	-	-	-	137	95	33	1	4	-
LEDFOG101-INF-M	4052899301757	-	-	-	114	97.5	90	1	4	-

1) LEDCBCTRL103 (P.34) avoids error messages on the board computer when using LED fog lights within 50W applications
 2) Refer to www.osram.com/am-guarantee for precise conditions | 3) Product measurements



Main benefits of FOG PL¹⁾ (LEDFOG103)

- Five-year guarantee²⁾
- LED fog light with daytime running light functionality
- Powerful performance thanks to xenon-like projector lens
- Available in three stylish colors – silver, gold and blue
- Color temperatures of up to 6,000 K
- Long lifetime of up to 5,000 h
- Simple installation thanks to built-in control box

Main benefits of F1¹⁾ (LEDFOG201)

- Three-year guarantee²⁾
- LED fog light
- Lens resistant to gravel impact according to ASTM D256 and ISO 179
- Color temperatures of up to 6,000 K
- Long lifetime of up to 5,000 h
- Simple installation thanks to built-in control box

Main benefits of mounting bracket

- Two-year guarantee²⁾
- Available for: Toyota, Volkswagen, Nissan and Infiniti car models
- Fits most car models with 90-mm fog lights



Check the compability of your car!
Vehicle Finder: www.osram.com/fog-finder



OSRAM LEDDriving® FOG PL and LEDDriving® F1 product range

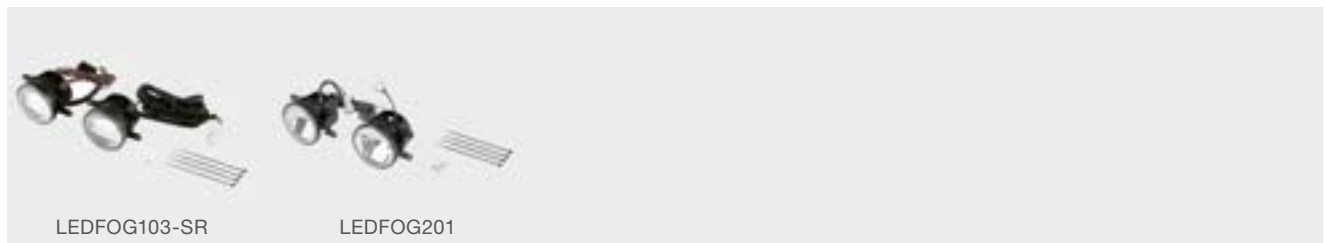

Product Reference	Product Number	V	W	K	l ³⁾ [mm]	w ³⁾ [mm]	h ³⁾ [mm]			No.
LEDFOG103-SR	4052899 288898	12	4/12	6.000	114	95	90	1	4	-
LEDFOG103-GD	4052899 288911	12	4/12	6.000	114	95	90	1	4	-
LEDFOG103-BL	4052899 288959	12	4/12	6.000	114	95	90	1	4	-
LEDFOG201	4052899 197985	12	8	6.000	114	95.5	90	1	4	-

OSRAM LEDDriving® mounting bracket product range



Product Reference	Product Number	V	W	K	l ³⁾ [mm]	w ³⁾ [mm]	h ³⁾ [mm]			No.
FOG103/201-TY-M	4052899 223394	-	-	-	120	96	77	1	4	-
FOG103/201-VW-M	4052899 274457	-	-	-	101	74	96	1	4	-
FOG103/201-NIS-M	4052899 274471	-	-	-	140	89	77	1	4	-

1) LEDCBCTRL103 (P.34) avoids error messages on the board computer when using LED fog lights within 50W applications

2) Refer to www.osram.com/am-guarantee for precise conditions | 3) Product measurements



OSRAM LEDriving[®] FOG LAMPs

Light is maximum visibility

With LED technology and a color temperature of 6,000 K, the OSRAM LEDriving[®] FOG LAMP represents the most convenient solution in order to upgrade your existing fog lights – providing a stylish cool white look as well as improved visibility for everything that lies ahead of you. It can be installed in place of most H8/H11/H16 or H10 fog headlights, and installation itself is simple. The fog light comes with a 5-year OSRAM guarantee and, thanks to advanced airflow technology, with a long service life.

Main benefits¹⁾

- Five-year guarantee²⁾
- LED replacement for conventional H8/H11/H16 and H10 fog lamps
- Color temperature of 6,000 K
- Extreme bright white light for better visibility
- Advanced airflow technology for a longer lifetime
- No glaring thanks to an optimized light distribution
- Perfect color match with xenon and LED headlights
- Please note: These lamps are not approved for use on public roads. Use on public roads leads to cancellation of operating license and loss of insurance coverage



OSRAM LEDDriving® FOG LAMPs product range¹⁾

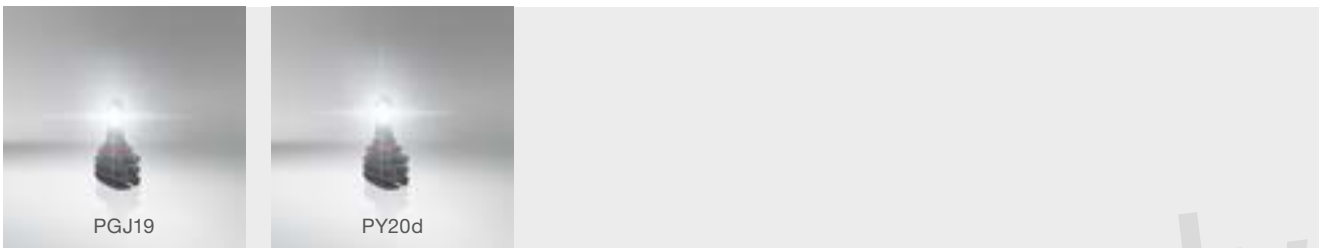

Product Reference	Product Number	V	W		K	COLOR			No.
66220CW	4052899 465619	12	13	PGJ19	6.000	Cool White	2	4	109 ^{P.117}
9645CW	4052899 465039	12	13	PY20d	6.000	Cool White	2	4	110 ^{P.117}

1) These products do not have ECE approval. This means they must not be used on public roads

2) Refer to www.osram.com/am-guarantee for precise conditions



OSRAM LEDriving® RETROFITS

Wide range of different light colors

From dome light to foot area, from glove box to trunk, simply replace old lamps with OSRAM's plug-and-play LEDriving® PREMIUM / STANDARD RETROFITS to benefit from highly energy-efficient bright color temperatures available in different color options.



Main benefits of LEDriving® PREMIUM RETROFITS¹⁾²⁾

- Six-year guarantee³⁾
- Perfect LED light thanks to modern diffuser material
- Non-selective illumination thanks to homogeneous light distribution
- Wide range of different light colors for a variety of customization options
- Shockproof and vibration-proof
- Up to 80% less energy consumption⁴⁾
- Simple plug & play replacement



Main benefits of LEDriving® STANDARD RETROFITS¹⁾²⁾

- Four-year guarantee³⁾
- Multiple light colors for a variety of customization options
- Non-selective illumination thanks to homogeneous light distribution
- Simple plug & play replacement



OSRAM LEDriving® PREMIUM / STANDARD RETROFIT range – INTERIOR¹⁾



Product Reference	Product Number	V	W			K						
PREMIUM ↓	2850WW-02B	Page 134	12	1	W2.1x9.5d	-	4.000	-	Warm White	2	10	79 ^{P.117}
	2850CW-02B	Page 134	12	1	W2.1x9.5d	-	6.000	-	Cool White	2	10	79 ^{P.117}
	2850BL-02B	Page 134	12	1	W2.1x9.5d	-	-	430-490	Blue	2	10	79 ^{P.117}
	2855YE-02B	Page 134	12	1	W2.1x9.5d	-	-	592	Amber	2	10	83 ^{P.117}
	3850WW-02B	Page 134	12	1	BA9s	-	4.000	-	Warm White	2	10	105 ^{P.117}
	3850CW-02B	Page 134	12	1	BA9s	-	6.000	-	Cool White	2	10	105 ^{P.117}
	6497WW-01B	Page 134	12	1	SV8.5-8	31	4.000	-	Warm White	1	5	97 ^{P.117}
	6497CW-01B	Page 135	12	1	SV8.5-8	31	6.000	-	Cool White	1	5	97 ^{P.117}
	6498WW-01B	Page 135	12	1	SV8.5-8	36	4.000	-	Warm White	1	5	92 ^{P.117}
	6498CW-01B	Page 135	12	1	SV8.5-8	36	6.000	-	Cool White	1	5	92 ^{P.117}
	6499WW-01B	Page 135	12	1	SV8.5-8	41	4.000	-	Warm White	1	5	100 ^{P.117}
	6499CW-01B	Page 135	12	1	SV8.5-8	41	6.000	-	Cool White	1	5	100 ^{P.117}
	2824WW-02B	Page 135	24	1	W2.1x9.5d	-	4.000	-	Warm White	2	10	79 ^{P.117}
	2824CW-02B	Page 135	24	1	W2.1x9.5d	-	6.000	-	Cool White	2	10	79 ^{P.117}
STANDARD ↓	2880BL-02B	Page 135	12	0.5	W2.1x9.5d	-	-	460-485	Blue	2	10	80 ^{P.117}
	2880CW-02B	Page 135	12	0.5	W2.1x9.5d	-	6.000	-	CoolWhite	2	10	80 ^{P.117}
	2880YE-02B	Page 135	12	1	W2.1x9.5d	-	-	592	Amber	2	10	80 ^{P.117}
	2880R-02B	Page 135	12	0.5	W2.1x9.5d	-	-	617-621	Red	2	10	80 ^{P.117}
	2880GR-02B	Page 135	12	1	W2.1x9.5d	-	-	617-621	Green	2	10	80 ^{P.117}
	6431CW-01B	Page 135	12	0.5	SV8.5-8	31	6.000	-	CoolWhite	1	5	96 ^{P.117}
	6431BL-01B	Page 135	12	0.5	SV8.5-8	31	-	460-485	Blue	1	5	96 ^{P.117}
	6436CW-01B	Page 135	12	0.5	SV8.5-8	36	6.000	-	CoolWhite	1	5	93 ^{P.117}
	6436BL-01B	Page 135	12	0.5	SV8.5-8	36	-	460-485	Blue	1	5	93 ^{P.117}
	6441CW-01B	Page 135	12	0.5	SV8.5-8	41	6.000	-	CoolWhite	1	5	99 ^{P.117}
	6441BL-01B	Page 135	12	0.5	SV8.5-8	41	-	460-485	Blue	1	5	99 ^{P.117}



Replace your traditional lamps with LED retrofit lamps.
Visit www.osram.com/retrofit-exchange

- 1) INTERIOR ONLY.** These products do not have ECE approval. This means they must not be fitted in any exterior automotive application.
- LEDCBCTRL101 and LEDCBCTRL102 (P.34) avoid error messages on the board computer when using LED retrofits within 5 W or 21 W applications
- Refer to www.osram.com/am-guarantee for precise conditions
- Compared with traditional lamps

OSRAM LEDriving® RETROFITS

Wide range of different light colors

Perfect for a multitude of applications, OSRAM LEDriving® PREMIUM / STANDARD RETROFITS illuminate vehicle exteriors with high color temperatures of up to 6,000 K. Thanks to their homogeneous light distribution, illumination is non-selective. OSRAM LED retrofits come with easy plug and play replacement, long life spans, low energy consumption – and 100% more style.



Main benefits of LEDriving® PREMIUM RETROFITS¹⁾²⁾

- Six-year guarantee³⁾
- Perfect LED light thanks to modern diffuser material
- Non-selective illumination thanks to homogeneous light distribution
- Wide range of different light colors for a variety of customization options
- Shockproof and vibration-proof
- Up to 80% less energy consumption⁴⁾
- Simple plug & play replacement
- Please note: These lamps are not approved for use on public roads. Use on public roads leads to cancellation of operating license and loss of insurance coverage



Main benefits of LEDriving® STANDARD RETROFITS¹⁾²⁾

- Four-year guarantee³⁾
- Multiple light colors for a variety of customization options
- Non-selective illumination thanks to homogeneous light distribution
- Simple plug & play replacement
- Please note: These lamps are not approved for use on public roads. Use on public roads leads to cancellation of operating license and loss of insurance coverage



OSRAM LEDriving® PREMIUM / STANDARD RETROFIT range – EXTERIOR¹⁾



Product Reference	Product Number	V	W			K	λ [nm]	COLOR			No.	
PREMIUM ↓	1557CW-02B	Page 134	12	2/0.4	BAY15d	-	6.000	-	Cool White	2	10	54 ^{P.117}
	1557R-02B	Page 134	12	2/0.4	BAY15d	-	-	617-621	Red	2	10	54 ^{P.117}
	1557YE-02B	Page 134	12	2/0.4	BAY15d	-	-	592	Amber	2	10	54 ^{P.117}
	3557CW-02B	Page 134	12	1.42/0.54	W2.5x16q	-	6.000	-	Cool White	2	10	63 ^{P.117}
	3557R-02B	Page 134	12	1.42/0.54	W2.5x16q	-	-	617-621	Red	2	10	63 ^{P.117}
	3557YE-02B	Page 134	12	1.42/0.54	W2.5x16q	-	-	592	Amber	2	10	63 ^{P.117}
	7556CW-02B	Page 135	12	2	BA15s	-	6.000	-	Cool White	2	10	51 ^{P.117}
	7556R-02B	Page 135	12	2	BA15s	-	-	617-621	Red	2	10	51 ^{P.117}
	7556YE-02B	Page 135	12	2	BA15s	-	-	592	Amber	2	10	51 ^{P.117}
	7557YE-02B	Page 135	12	2	BAU15s	-	-	592	Amber	2	10	57 ^{P.117}
	7905CW-02B	Page 135	12	3	W3x16d	-	6.000	-	Cool White	2	10	73 ^{P.117}
	7905R-02B	Page 135	12	1.5	W3x16d	-	-	617-621	Red	2	10	73 ^{P.117}
	7905YE-02B	Page 135	12	1.5	W3x16d	-	-	592	Amber	2	10	76 ^{P.117}
	7915CW-02B	Page 135	12	3	W3x16q	-	6.000	-	Cool White	2	10	70 ^{P.117}
	7915R-02B	Page 135	12	1.5	W3x16q	-	-	617-621	Red	2	10	70 ^{P.117}
	7915YE-02B	Page 135	12	1.5	W3x16q	-	-	592	Amber	2	10	70 ^{P.117}
	9213CW-02B	Page 135	12	3	W2.1x9.5d	-	6.000	-	Cool White	2	10	86 ^{P.117}
9213R-02B	Page 135	12	2	W2.1x9.5d	-	-	617-621	Red	2	10	86 ^{P.117}	
3924WW-02B	Page 135	24	1	BA9s	-	4.000	-	Warm White	2	10	105 ^{P.117}	
3924CW-02B	Page 135	24	1	BA9s	-	6.000	-	Cool White	2	10	105 ^{P.117}	
STANDARD ↓	1457CW-02B	Page 135	12	2/0.4	BAY15d	-	6.000	-	Cool White	2	10	55 ^{P.117}
	1457R-02B	Page 135	12	2/0.4	BAY15d	-	-	617-621	Red	2	10	55 ^{P.117}
	1457YE-02B	Page 135	12	2/0.4	BAY15d	-	-	592	Amber	2	10	55 ^{P.117}
	3547CW-02B	Page 135	12	2.5	W2.5x16q	-	6.000	-	Cool White	2	10	64 ^{P.117}
	3547R-02B	Page 135	12	3	W2.5x16q	-	-	617-621	Red	2	10	64 ^{P.117}
	3547YE-02B	Page 135	12	1	W2.5x16q	-	-	592	Amber	2	10	64 ^{P.117}
	7456CW-02B	Page 135	12	2	BA15s	-	6.000	-	Cool White	2	10	50 ^{P.117}
	7456R-02B	Page 135	12	2	BA15s	-	-	617-621	Red	2	10	50 ^{P.117}
	7456YE-02B	Page 135	12	2	BA15s	-	-	592	Amber	2	10	50 ^{P.117}
	7457YE-02B	Page 135	12	2	BAU15s	-	-	592	Amber	2	10	58 ^{P.117}
	7705CW-02B	Page 135	12	2.5	W3x16d	-	6.000 K	-	Cool White	2	10	74 ^{P.117}
	7705R-02B	Page 135	12	3	W3x16d	-	-	617-621	Red	2	10	74 ^{P.117}
	7705YE-02B	Page 135	12	1	W3x16d	-	-	592	Amber	2	10	77 ^{P.117}
	7715CW-02B	Page 135	12	2.5	W3x16q	-	6.000 K	-	Cool White	2	10	71 ^{P.117}
	7715R-02B	Page 135	12	3	W3x16q	-	-	617-621	Red	2	10	71 ^{P.117}
7715YE-02B	Page 135	12	1	W3x16q	-	-	592	Amber	2	10	71 ^{P.117}	
9212CW-02B	Page 135	12	1.8	W2.1x9.5d	-	6.000 K	-	Cool White	2	10	87 ^{P.117}	

i Replace your traditional lamps with LED retrofit lamps.
Visit www.osram.com/retrofit-exchange

1) These products do not have ECE approval. This means they must not be used on public roads.

2) LEDCBCTRL101 and LEDCBCTRL102 (P.34) avoid error messages on the board computer when using LED retrofits within 5 W or 21 W applications

3) Refer to www.osram.com/am-guarantee for precise conditions

OSRAM LEDriving® CANBUS CONTROL UNIT

Making LED upgrades fit right in

LED lamps are highly energy-efficient. But their lower wattages prompt board computer warnings. The OSRAM solution: the Canbus Control Unit. It prevents warnings and allows the lightsource to run cool and retain their brightness. Simply clip the warning canceller between lamp and socket, and enjoy full benefits of your OSRAM LED retrofits and fog lights.



Main benefits

- Three-year guarantee¹⁾
- Bypasses the vehicle's outage detection system to prevent error messages in board computers prompted by LED lamps with lower wattages, such as 4-5 W, 21 W or 50 W
- Easy to install
- Easily clips onto wires



OSRAM LEDDriving® CANBUS CONTROL UNIT product range¹⁾

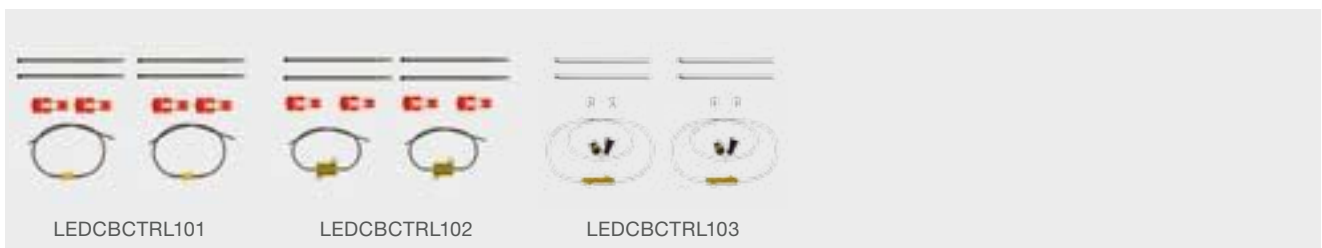

Product Reference	Product Number	V	W			
LEDCBCTRL101	4052899090873	12	5	2	10	-
LEDCBCTRL102	4052899301993	12	21	2	10	-
LEDCBCTRL103	4052899327375	12	50	2	10	-

¹⁾ Refer to www.osram.com/am-guarantee for precise conditions



OSRAM LEDambient® CONNECT

Light is pulsating

LEDambient® CONNECT customizes the vehicle's look with quality LED products designed to add colors to the vehicle. Simple to install, these innovative LED products use Bluetooth® technology. Once paired to the free OSRAM LEDambient® CONNECT app music can be synchronized to up to 10 LEDambient® CONNECT systems to pulse to the same beat, colors can be preset, and can all be controlled with one device. All of these products connect directly to battery or 12 V power source with no switch required.

Main benefits of PULSE CONNECT¹⁾²⁾

- Two-year guarantee³⁾
- Small disk with chrome finish that blends-in with your headlight assembly making it barely visible
- Easy to install. Mounts to outer headlight assembly surface
- Shines color back onto reflector
- Can be installed in the cars' interior as well

Main benefits of HYBRID CONNECT¹⁾²⁾

- Two-year guarantee³⁾
- Discreet system that adds color to your headlights from the inside
- High-performance halogen bulbs with up to 4,200 K and up to 20% more brightness that are enhanced with color-changing LEDs
- Easy to install. Mounts by replacing your existing headlight bulbs
- Fills your reflector with color through the bulbs
- Available as HB3, HB4 and H10
- Please note: These lamps are not approved for use on public roads. Use on public roads leads to cancellation of operating license and loss of insurance coverage



Download the app
www.osram.com/ledambient-app

Main benefits of TUNING LIGHTS CONNECT⁴⁾

- Two-year guarantee³⁾
- App controlled flexible self-adhesive LED strips providing RGB styling to the interior of the vehicle
- Easy to install with no soldering or use of screws
- Extension kit available



OSRAM LEDambient® PULSE CONNECT product range

Product Reference	Product Number	V	COLOR			No.
LEDEXT101	4052899408104	12	Multicolor	1	2	-
LEDINT103	4052899408081	12	Multicolor	1	2	-

OSRAM LEDambient® HYBRID CONNECT product range

Product Reference	Product Number	V	W				No.
LEDEXT102-03	4052899490581	12	60	P20d	1	2	-
LEDEXT102-04	4052899490604	12	51	P22d	1	2	-
LEDEXT102-10	4052899490628	12	42	PY20d	1	2	-

OSRAM LEDambient® TUNING LIGHTS CONNECT

Product Reference	Product Number	V	COLOR	KIT			No.
LEDINT102	4052899451575	12	Multicolor	Base Kit	1	2	-
LEDINT104	4052899474529	12	Multicolor	Extension Kit	1	2	-

- 1) These products do not have ECE approval. This means they must not be used on public roads. Please note: Use on public roads leads to cancellation of operating license and loss of insurance coverage. Products not for sale in Germany.
- 2) Do not use while driving
- 3) Refer to www.osram.com/am-guarantee for precise conditions
- 4) INTERIOR ONLY. These products do not have ECE approval. This means they must not be fitted in any exterior automotive application.

OSRAM LEDambient®

Stylish interior ambient lighting

The LEDambient® lights for the interior refresh every car, are attractive and pleasant, and have an appealing contemporary touch. The LED strips are rapidly and easily mounted.



Main benefits of LEDambient® TUNING LIGHTS¹⁾

- Two-year guarantee²⁾
- Flexible 16-color LED strips with adhesive backing
- 24-button wireless remote control
- Dimmable and 4 flashing modes
- Adapter included for auto accessory plug-in
- Extension kit available



Main benefits LEDambient® INTERIOR STRIP KIT¹⁾

- Two-year guarantee²⁾
- Flexible self-adhesive LED strips (2 x 1.5m)
- High brightness
- Light color: white
- Easy to install with no soldering or use of screws
- 90 LED pieces per 1.5m
- Individual shortenable after every third LED



OSRAM LEDambient® TUNING LIGHTS product range



Product Reference	Product Number	V	COLOR	KIT			No.
LEDINT201	4052899933576	12	Multicolor	Base Kit	1	2	-
LEDINT201-SEC	4052899248809	12	Multicolor	Base Kit	1	2	-
LEDINT202 ³⁾	4052899933590	12	Multicolor	Extension Kit	1	2	-

OSRAM LEDambient® INTERIOR STRIP KIT product range

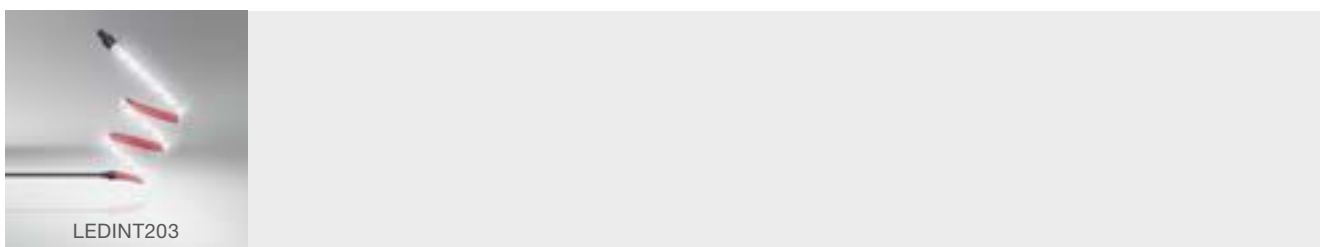

Product Reference	Product Number	V	COLOR	KIT			No.
LEDINT203	4052899516670	12	White color	-	1	2	-

1) INTERIOR ONLY. These products do not have ECE approval. This means they must not be fitted in any exterior automotive application.

2) Refer to www.osram.com/am-guarantee for precise conditions

3) Only works in combination with the base kit

OSRAM LEDinspect® PRO

Essential to your garage

A full line of premium inspection lights, specially-developed for the complex maintenance and repairs you tackle every day, reinvents light, turning it into a functional tool for your garage. LEDinspect® PRO enhances visibility with advanced LEDs that deliver exceptional luminosity. Each unique light design reflects an understanding of professional applications and supplies light precisely where you need it. Many lights include features such as magnets, clips, hooks, torches, and extensions to direct light and give you hands-free options.



Main benefits of SLIMLINE 280 (LEDIL103)

- Three-year guarantee¹⁾
- Luminance: 280 lm (main light), 70 lm (torch light)
- Equipped with 10+1 high-quality, long-lasting LEDs
- 180 degree bending mechanism
- Battery status display
- Easy charge via USB port & DC/AC (with charging cable)
- Rechargeable 2,000 mAh Li-ion battery



Main benefits of BONNET 1400 (LEDIL104)

- Three-year guarantee¹⁾
- Luminance: 1400 lm
- Equipped with 168 high-quality, long-lasting LEDs
- Working lamp with hook to be used without the bracket
- Extendable bracket for mounting under the bonnet of the car
- Operable via 5 m cable





**Main benefits of
PENLIGHT 150 (LEDIL105)**

- Three-year guarantee¹⁾
- Luminance: 150 lm (main light), 35 lm (torch light)
- Equipped with 6 high-quality, long-lasting LEDs
- Rechargeable 800 mAhLi-Polymer battery
- Easy charge via USB port & DC/AC (with charging cable)
- Easy to grip and dirt resistant surface



**Main benefits of
PENLIGHT 150 UV-A (LEDIL106)**

- Three-year guarantee¹⁾
- Luminance: 150 lm (main light), UV light (torch light)
- Integrated UV light (e.g. for identifying leaks in the air condition)
- Equipped with 6 high-quality, long-lasting LEDs
- Rechargeable 800 mAhLi-Polymer battery
- Easy charge via USB port & DC/AC (with charging cable)
- Easy to grip and dirt resistant surface



1) Refer to www.osram.com/am-guarantee for precise conditions





**Main benefits of
POCKET 280 (LEDIL107)**

- Three-year guarantee¹⁾
- Luminance: 280 lm (main light), 70 lm (torch light)
- Equipped with 3+1 high-quality, long-lasting LEDs
- 360 degree rotation of hook
- Rechargeable 3.7 V 2,000 mAh Li-Polymer battery
- Easy charge via USB port & DC/AC (with charging cable)





OSRAM LEDinspect® PRO product range

Product Reference	Product Number	V	W	lm	lx	K	$\frac{l}{[mm]}$ ³⁾	$\frac{w}{[mm]}$ ³⁾	$\frac{h}{[mm]}$ ³⁾			 No.
LEDIL103	4052899 327351	3.4	3.5	280	500 ²⁾	6.000	285	37	26	1	4	-
LEDIL104	4052899 970632	220	13-15	1.400	900 ²⁾	6.000	1104	50	50	1	4	-
LEDIL105	4052899 963825	3.7	0.5	150/35	300/100 ²⁾	6.000	177	23	19.5	1	4	-
LEDIL106	4052899 963849	3.7	0.5	150/UVA	300 ²⁾	6.000	177	23	19.5	1	4	-
LEDIL107	4052899 963863	3.7	1	280/70	480/500 ²⁾	6.000	133	65	21	1	4	-

1) Refer to www.osram.com/am-guarantee for precise conditions

2) Up to

3) Product measurements

OSRAM LEDinspect®

Essential to your DIY toolbox

LEDinspect® simplifies DIY projects – specially-developed for maintaining and repairing vehicles, transforms light from an afterthought into a functional tool. The design of each lamp takes into account how the light is used and includes different extra features such as magnets, clips, hooks, and rotatable heads, all housed in perfectly-sized packages and various light settings to ease work.



Main benefits of FOLDABLE 80 (LEDIL201)

- Two-year guarantee¹⁾
- Luminance: 80 lm (main light), 25 lm (torch light)
- Equipped with 21+5 high-quality, long-lasting LEDs
- Battery status display
- Rechargeable Ni-Mh 3.6 V 1600 mAh battery
- Rechargeable via 220 V adapter and 12 V cigarette lighter



Main benefits of MINI 125 (LEDIL202)

- Two-year guarantee¹⁾
- Luminance: 125 lm (main light), 90 lm (torch light)
- Equipped with 24+3 high-quality, long-lasting LEDs
- Three AAA batteries (included)
- Easy to grip and dirt resistant surface



DENNIS PUBLISHING LIMITED



**Main benefits of
PENLIGHT 80 (LEDIL203)**

- Two-year guarantee¹⁾
- Luminance: 80 lm (main light)
- Equipped with 8 high-quality, long-lasting LEDs
- Three AAA batteries (included)
- Easy to grip and dirt resistant surface



**Main benefits of
POCKET 160 (LEDIL204)**

- Two-year guarantee¹⁾
- Luminance: 160 lm (high), 75 lm (low)
- Equipped with 5 high-quality, long-lasting LEDs
- Rechargeable 3.7V 1500mAh Li-ion battery
- Easy charge via USB port & DC/AC (with charging cable)
- Easy to grip and dirt resistant surface



**Main benefits of
FLASHLIGHT 15 (LEDIL205)**

- Two-year guarantee¹⁾
- Luminance: 15 lm
- Equipped with 1 high-quality, long-lasting LED
- Rechargeable 3.6V 80mAh Ni-Mh battery
- Easy charge via 12 V cigarette lighter



¹⁾ Refer to www.osram.com/am-guarantee for precise conditions



**Main benefits of
SLIMLINE 250 (LEDIL206)**

- Two-year guarantee¹⁾
- Luminance: 250 lm (main light), 30 lm (torch light)
- Equipped with 15+2 high-quality, long-lasting LEDs
- Rechargeable 3.7 V 2600mAh Li-ion battery
- Easy charge via USB port & DC/AC (with charging cable)
- Easy to grip and dirt resistant surface



**Main benefits of
PROFESSIONAL 150 (LEDIL207)**

- Two-year guarantee¹⁾
- Luminance: 150 lm (main light), 70 lm (torch light)
- Equipped with 6+1 high-quality, long-lasting LEDs
- 3.7V 2000mAh Li-ion battery
- Easy charge via USB port & DC/AC (with charging cable)
- Easy to grip and dirt resistant surface





**Main benefits of
HEADLAMP 300 (LEDIL209)**

- Two-year guarantee¹⁾
- Luminance: 300 lm (100%), 60 lm (20%)
- Equipped with 1 high-quality, long-lasting LED
- Three AA batteries (included)
- Headlamp with 75% angle adjustment
- Hand-free working thanks to head fixing
- Size adjustable headband gives best stability





OSRAM LEDinspect® product range

Product Reference	Product Number	V	W	Im	lx	K	$\frac{l}{[mm]}$ ³⁾	$\frac{w}{[mm]}$ ³⁾	$\frac{h}{[mm]}$ ³⁾			 No.
LEDIL201	4052899009592	4.5	1.5	80/25	2000 ²⁾	6.000	220	46	51	1	10	-
LEDIL202	4052899009578	4.5	1.6	125/90	1200 ²⁾	6.000	98	63	35	1	24	-
LEDIL203	4052899275607	4.5	1.5	80	250 ²⁾	7.000	160	16	31.5	1	12	-
LEDIL204	4052899424975	3.7	0.5	160/75	70/30 ²⁾	7.000	127	63	34	1	4	-
LEDIL205	4052899424951	3.6	0.5	15	56 ²⁾	7.000	61	22.5	-	1	10	-
LEDIL206	4052899424999	3.7	3	250/30	96/20 ²⁾	7.000	320	38	25	1	4	-
LEDIL207	4052899425019	3.7	3	150/70	58/217 ²⁾	7.000	210	51	40	1	4	-
LEDIL209	4052899425033	4.5	3	300/60	272/43 ²⁾	7.000	90	89	68	1	4	-

1) Refer to www.osram.com/am-guarantee for precise conditions

2) Up to

3) Product measurements



OSRAM LEDguardian® warning lights

Prepared for serious situations

Two lights that should accompany every trip. ROAD FLARE is a powerful emergency flare, for signalling serious situations and improving visibility. SAVER LIGHT is a multifunctional torch that includes a seat-belt cutter, life hammer and flashing LED warning lights.



Main benefits of LEDguardian® ROAD FLARE¹⁾

- Two-year guarantee²⁾
- Two different modes and a torch function in one product
- Equipped with 16 high-quality, long-lasting LEDs (12 amber LEDs, 4 white LEDs)
- Two modes: yellow light – flashing and continuous-on
- Torch function: white light
- Visible at range of up to 240 m
- Crush-proof – doesn't break even when run over by a car³⁾
- Fastened via magnet on back and key hang buckle



Main benefits of LEDguardian® SAVER LIGHT PLUS¹⁾

- Two-year guarantee²⁾
- Easy-grip and dirt-resistant surface
- Emergency hammer
- Seat belt knife
- Equipped with twelve high-quality, long-lasting LEDs
- Twelve flashing amber LEDs in handle as warning light
- Torch function: white light
- Holder included for mounting in car
- Three magnets included for attachment to metal surfaces





OSRAM LEDguardian® ROAD FLARE

Product Reference	Product Number	V	W	COLOR	l ⁴⁾ [mm]	w ⁴⁾ [mm]	h ⁴⁾ [mm]			No.
LEDSL302	4052899184053	4.5	0.5	Amber	110	42	-	1	24	-

OSRAM LEDguardian® SAVER LIGHT PLUS

Product Reference	Product Number	V	W	COLOR	l ⁴⁾ [mm]	w ⁴⁾ [mm]	h ⁴⁾ [mm]			No.
LEDSL101	4052899132344	3	1.7	Amber	180	63	53	1	6	-

1) Not approved as warning light according to German Road Traffic Licensing Regulations (StVZO).
 2) Refer to www.osram.com/am-guarantee for precise conditions
 3) Tested in a mid-range car at walking pace
 4) Product measurements

OSRAM ONYX COPILOT®

Good light for a good ride

OSRAM ONYX COPILOT® is a flexible LED reading light that emits a pleasantly warm, glare-free light. With an appealing black design, the ONYX COPILOT® is available in two versions: ONYX M-7 is powered via cigarette lighter, ONYX L-7 comes with a plastic base for fixed connection.



Main benefits

- Two-year guarantee¹⁾
- Reading light with LED lamp for vehicle interior
- Luminous flux: 20 lm
- Pleasant warm and glare-free light
- Individual adjustment thanks to bendable neck
- Pleasantly soft, easy to grip and dirt-resistant surface
- Light can be switched on/off and remain connected permanently
- Service life (LED): up to 20,000 h



OSRAM LED ONYX COPILOT® product range

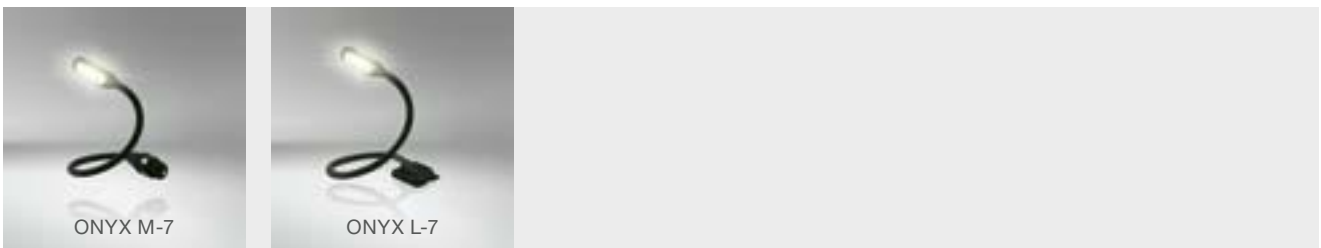

Product Reference	Product Number	V	W	lx	K	$\frac{l}{[mm]}$ ³⁾	$\frac{w}{[mm]}$ ³⁾	$\frac{h}{[mm]}$ ³⁾				No.
ONYX M-7	4052899 077270	12/24	0.5	20	3200	370 ²⁾	25.4	9	1	4	-	-
ONYX L-7	4052899 414938	12/24	0.5	20	3200	370 ²⁾	25.4	9	1	4	-	-

1) Refer to www.osram.com/am-guarantee for precise conditions

2) Not overall length of product

3) Product measurements

Xenon headlight lamps – fascinatingly bright

OSRAM xenon lamps generate up to 70% more light than halogen lamps – at impressive color temperatures, significantly lower energy consumption, and longer life. OSRAM cutting-edge xenon lighting concepts however, allow far more than just driving comfort, underlining personal style and demonstrating individual environmental awareness. They are suitable for cars, trucks, buses and commercial vehicles.





OSRAM Trust Program

Verify original OSRAM xenon lamps

OSRAM strives to deliver premium-quality products – a fact that has garnered the attention of manufacturers who flood the market with fakes. This is not just an economic issue, but one that puts customer safety at stake. The OSRAM Trust Program helps customers to verify OSRAM original xenon products.

Why trusting OSRAM is always the right thing to do

There are already a certain number of fake lamps circulating, many of which claim to be OSRAM XENARC® lamps. Some of those fakes are easy to spot. But some are so cleverly faked, even the eye of a professional can't spot the difference.

That's why we have implemented a 2-step security process. It's easy to use and guaranteed to get you results within seconds.

OSRAM XENARC® lamps

- XENARC® NIGHT BREAKER® UNLIMITED
- XENARC® COOL BLUE® INTENSE
- XENARC® ULTRA LIFE
- XENARC® ORIGINAL

Safety features

One part of the OSRAM Trust Program is to implement two safety features into the manufacturing process. Starting with OSRAM XENARC® products, you can verify your lamps using the following two safety features:



Packaging label code

Every original OSRAM xenon packaging has a unique 7-digit label code **a** attached, the last 3 digits of which can be seen as a hologram in the lower right corner **b**. Next you'll find a security strip with microtext which is legible with a magnifying glass **c**. Finally there's an OSRAM logo, the URL www.osram.com/trust and a QR code leading to our OSRAM Trust Program website.

Unique lamp data on each lamp

Each safety label is assigned to exactly one lamp during the manufacturing process. You can find the unique lamp data on the base of your lamp.



Online check tool

This is part 2 of the OSRAM Trust Program. We strongly encourage you to try these next steps two or three times in a row – it's fast and simple:



www.osram.com/trust



1 Enter 7-digit label code

When at osram.com/trust, select the tab "Verify your product" then enter the 7-digit label code from the packaging. If you're scanning a QR code right from the packaging, the 7-digit label code is already being auto-filled.

2 Verify lamp data

After your 7-digit label code has been verified, you will be asked to check whether the automatically prompted lamp data matches the data which is displayed on the base of your lamp.

OSRAM XENARC® NIGHT BREAKER® UNLIMITED

Brightest OSRAM xenon light

With up to 70% more light on the road, these exceptional headlight lamps come with even whiter xenon light and a beam up to 20 meters longer than standard xenon lamps.



Main benefits

- Up to 70% more light¹⁾ for better visibility and significantly shorter reaction times
- Up to 20 m longer light beam²⁾
- Up to 5% whiter light¹⁾
- Color temperatures of up to 4,300 K

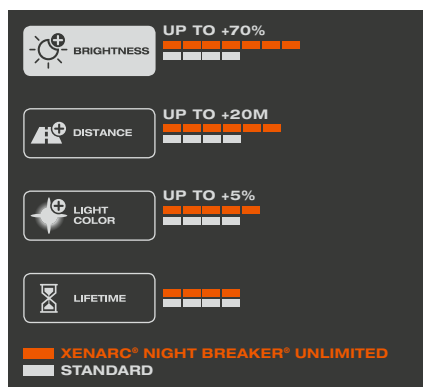



OSRAM XENARC® NIGHT BREAKER® UNLIMITED product range

Product Reference	ECE	Product Number	V	W		lm	K			
66140XNB ³⁾⁴⁾	D1S ⁵⁾	4052899 047068	85	35	PK32d-2	3200 ⁶⁾	4300	1	4	1 ^{P.116}
66140XNB-HCB ³⁾⁴⁾	D1S ⁵⁾	Page 131	85	35	PK32d-2	3200 ⁶⁾	4300	2	10	1 ^{P.116}
66240XNB ³⁾⁴⁾	D2S ⁵⁾	4052899 047082	85	35	P32d-2	3200 ⁶⁾	4300	1	4	3 ^{P.116}
66240XNB-HCB ³⁾⁴⁾	D2S ⁵⁾	Page 131	85	35	P32d-2	3200 ⁶⁾	4300	2	10	3 ^{P.116}
66340XNB ³⁾⁴⁾	D3S ⁵⁾	4052899 340664	42	35	PK32d-5	3200 ⁶⁾	4300	1	4	1 ^{P.116}
66340XNB-HCB ³⁾⁴⁾	D3S ⁵⁾	Page 131	42	35	PK32d-5	3200 ⁶⁾	4300	2	10	1 ^{P.116}
66440XNB ³⁾⁴⁾	D4S ⁵⁾	4052899 343436	42	35	P32d-5	3200 ⁶⁾	4300	1	4	3 ^{P.116}
66440XNB-HCB ³⁾⁴⁾	D4S ⁵⁾	Page 131	42	35	P32d-5	3200 ⁶⁾	4300	2	10	3 ^{P.116}

1) When compared to standard xenon lamps
 2) Depending on the headlight system
 3) To be operated only with approved electronic control gear
 4) XENARC® lamps should be replaced by a qualified mechanic
 5) Reduced UV emission | For projection headlights | ECE approval and DOT label
 6) ± 450lm

OSRAM XENARC® COOL BLUE® INTENSE

Extra-blue xenon light

Exceptionally bright, high contrast and brilliantly blue with up to 6,000 K: innovative xenon light with highly efficient technology, brilliant effect and no-compromise design.



Main benefits

- Extra blue light¹⁾
- Color temperatures of up to 6,000 K
- Up to 20% more light²⁾
- Exceptionally bright
- Most stylish and modern look on the road

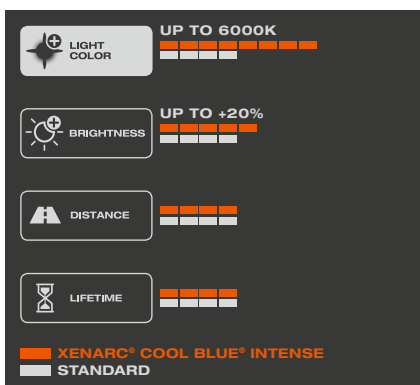



OSRAM XENARC® COOL BLUE® INTENSE product range

Product Reference	ECE	Product Number	V	W		lm	K			
66140CBI ⁽³⁾⁴⁾	D1S ⁽⁵⁾	4052899 220720	85	35	PK32d-2	3200 ⁽⁷⁾	6000 ⁽⁸⁾	1	4	1 ^{P.116}
66140CBI-HCB ⁽³⁾⁴⁾	D1S ⁽⁵⁾	Page 131	85	35	PK32d-2	3200 ⁽⁷⁾	6000 ⁽⁸⁾	2	10	1 ^{P.116}
66150CBI ⁽³⁾⁴⁾	D1R ⁽⁶⁾	4052899 339903	85	35	PK32d-3	2800 ⁽⁷⁾	6000 ⁽⁸⁾	1	4	2 ^{P.116}
66240CBI ⁽³⁾⁴⁾	D2S ⁽⁵⁾	400832 1401359	85	35	P32d-2	3200 ⁽⁷⁾	6000 ⁽⁸⁾	1	4	3 ^{P.116}
66240CBI-HCB ⁽³⁾⁴⁾	D2S ⁽⁵⁾	Page 131	85	35	P32d-2	3200 ⁽⁷⁾	6000 ⁽⁸⁾	2	10	3 ^{P.116}
66250CBI ⁽³⁾⁴⁾	D2R ⁽⁶⁾	400832 1401533	85	35	P32d-3	2800 ⁽⁷⁾	6000 ⁽⁸⁾	1	4	4 ^{P.116}
66340CB ⁽³⁾⁴⁾	D3S ⁽⁵⁾	4052899 148710	42	35	PK32d-5	3200 ⁽⁷⁾	6000 ⁽⁸⁾	1	4	1 ^{P.116}
66340CBI-HCB ⁽³⁾⁴⁾	D3S ⁽⁵⁾	Page 131	42	35	PK32d-5	3200 ⁽⁷⁾	6000 ⁽⁸⁾	2	10	1 ^{P.116}
66440CBI ⁽³⁾⁴⁾	D4S ⁽⁵⁾	4052899 125582	42	35	P32d-5	3200 ⁽⁷⁾	6000 ⁽⁸⁾	1	4	3 ^{P.116}
66440CBI-HCB ⁽³⁾⁴⁾	D4S ⁽⁵⁾	Page 131	42	35	P32d-5	3200 ⁽⁷⁾	6000 ⁽⁸⁾	2	10	3 ^{P.116}

1) From a special filling system instead of conventional coating
 2) Compared with standard coated gas discharge lamps
 3) To be operated only with approved electronic control gear
 4) XENARC® lamps should be replaced by a qualified mechanic
 5) Reduced UV emission | For projection headlights | ECE approval and DOT label
 6) Reduced UV emission | With anti-glare strip for reflection headlights | ECE approval and DOT label
 7) ± 450 lm
 8) Up to

OSRAM XENARC® ULTRA LIFE

Superior life span and a ten-year guarantee

For additional reliability and comfort: With up to four times the lifespan of a standard lamp, XENARC® ULTRA LIFE headlight lamps come with a ten-year guarantee.



Main benefits

- 10-year guarantee¹⁾
- Up to 4 times longer lifetime²⁾
- Up to 300,000 km service life³⁾
- More durability and longer replacement cycle

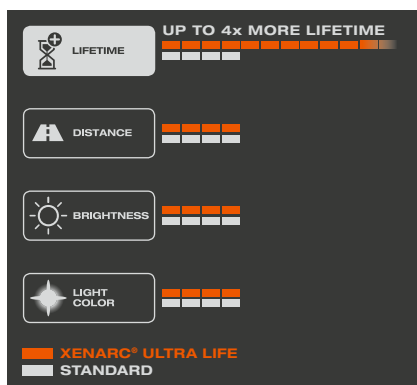



OSRAM XENARC® ULTRA LIFE product range

Product Reference	ECE	Product Number	V	W		lm	K			
66140ULT ⁴⁾⁵⁾	D1S ⁶⁾	4052899 425514	85	35	PK32d-2	3200 ⁷⁾	4300	1	4	1 ^{P.116}
66140ULT-HCB ⁴⁾⁵⁾	D1S ⁶⁾	Page 131	85	35	PK32d-2	3200 ⁷⁾	4300	2	10	1 ^{P.116}
66240ULT ⁴⁾⁵⁾	D2S ⁶⁾	4052899 425576	85	35	P32d-2	3200 ⁷⁾	4300	1	4	3 ^{P.116}
66240ULT-HCB ⁴⁾⁵⁾	D2S ⁶⁾	Page 131	85	35	P32d-2	3200 ⁷⁾	4300	2	10	3 ^{P.116}
66340ULT ⁴⁾⁵⁾	D3S ⁶⁾	4052899 425606	42	35	PK32d-5	3200 ⁷⁾	4300	1	4	1 ^{P.116}
66340ULT-HCB ⁴⁾⁵⁾	D3S ⁶⁾	Page 132	42	35	PK32d-5	3200 ⁷⁾	4300	2	10	1 ^{P.116}
66440ULT ⁴⁾⁵⁾	D4S ⁶⁾	4052899 425637	42	35	P32d-5	3200 ⁷⁾	4300	1	4	3 ^{P.116}
66440ULT-HCB ⁴⁾⁵⁾	D4S ⁶⁾	Page 132	42	35	P32d-5	3200 ⁷⁾	4300	2	10	3 ^{P.116}

1) With online product registration. Refer to www.osram.com/am-guarantee for precise conditions and registration

2) Compared to standard xenon lamps

3) With an average annual mileage of 14,259 km and 60% light on

4) To be operated only with approved electronic control gear

5) XENARC® lamps should be replaced by a qualified mechanic

6) Reduced UV emission | For projection headlights | ECE approval and DOT label

7) ± 450 lm

OSRAM XENARC® ORIGINAL

Four-year guarantee

With up to 4,500 K closer to the color temperature of natural daylight than conventional halogen light (3,200 K) and therefore easier on the eyes. Successfully used in millions of new automobiles from renowned manufacturers, whether as standard initial equipment or original spare parts. Latest innovation, OSRAM being the only manufacturer worldwide: the D8S, entirely mercury-free and with a power consumption of merely 25 W.



Main benefits

- 4-year guarantee¹⁾
- OEM quality
- Impressive brightness and reliability



OSRAM XENARC® ORIGINAL product range

Product Reference	ECE	Product Number	V	W		lm	K			
66140 ²⁾³⁾	D1S ⁴⁾	4008321184276	85	35	PK32d-2	3200 ⁶⁾	4300	1	4	1 ^{P.116}
66150 ²⁾³⁾	D1R ⁵⁾	4052899339828	85	35	PK32d-3	2800 ⁶⁾	4300	1	4	2 ^{P.116}
66240 ²⁾³⁾	D2S ⁴⁾	4008321184573	85	35	P32d-2	3200 ⁶⁾	4300	1	4	3 ^{P.116}
66250 ²⁾³⁾	D2R ⁵⁾	4008321184634	85	35	P32d-3	2800 ⁶⁾	4300	1	4	4 ^{P.116}
66340 ²⁾³⁾	D3S ⁴⁾	4052899199569	42	35	PK32d-5	3200 ⁶⁾	4300	1	4	1 ^{P.116}
66350 ²⁾³⁾	D3R ⁵⁾	4008321129857	42	35	PK32d-6	2800 ⁶⁾	4300	1	4	2 ^{P.116}
66440 ²⁾³⁾	D4S ⁴⁾	4008321349392	42	35	P32d-5	3200 ⁶⁾	4300	1	4	3 ^{P.116}
66450 ²⁾³⁾	D4R ⁵⁾	4008321349576	42	35	P32d-6	2800 ⁶⁾	4300	1	4	4 ^{P.116}
66548 ²⁾³⁾	D8S ⁴⁾	4008321787019	42	25	PK32d-1	2000 ⁷⁾	4500	1	4	1 ^{P.116}

A perfectly matched OSRAM system solution with ballast, terminal and connecting cables is available for all XENARC® D1S/R, D3S/R and D8S lamps. Please consult your OSRAM contact if required.

- 1) Refer to www.osram.com/guarantee for precise conditions
- 2) To be operated only with approved electronic control gear
- 3) XENARC® lamps should be replaced by a qualified mechanic
- 4) Reduced UV emission | For projection headlights | ECE approval and DOT label
- 5) Reduced UV emission | With anti-glare strip for projection headlights | ECE approval and DOT label
- 6) ± 450 lm
- 7) ± 300 lm

Halogen lamps for cars – the most popular classic light, for good reason

Long life or high performance, optimized illumination, best quality, convincing price-performance ratio – for these excellent reasons, OSRAM halogen solutions are the best-selling classics among headlight lamps. From original, performance, design, and comfort products, each customer can choose the exact lamp which best fits their personal needs – whether it is an original spare part or a value added product.



OSRAM NIGHT BREAKER® LASER

Brightest OSRAM halogen light

Outshining all other OSRAM halogen lamps: Innovative laser ablation technology makes the NIGHT BREAKER® LASER up to 130% brighter than standard lamps.





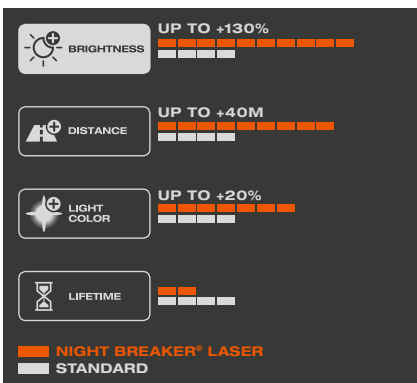

Main benefits

- Up to 130% more light¹⁾
- Up to 40 m longer beam¹⁾
- Up to 20% whiter light¹⁾
- Innovative laser ablation technology and precise window for better performance
- Combination of highly engineered filament and pure xenon gas filling for extra light output
- Unique design with laser-etched product name and silver cap





OSRAM NIGHT BREAKER® LASER product range

Product Reference	ECE	Product Number	V	W				 No.
64193NBL	H4	4052899 437845	12	60/55	P43t	1	100	14 ^{P.116}
64193NBL-01B	H4	Page 132	12	60/55	P43t	1	10	14 ^{P.116}
64193NBL-HCB	H4	Page 132	12	60/55	P43t	2	20	14 ^{P.116}
64210NBL	H7	4052899 437814	12	55	PX26d	1	100	19 ^{P.116}
64210NBL-01B	H7	Page 132	12	55	PX26d	1	10	19 ^{P.116}
64210NBL-HCB	H7	Page 132	12	55	PX26d	2	20	19 ^{P.116}

1) Compared with standard lamps

OSRAM NIGHT BREAKER® UNLIMITED

Up to 110% more light

With up to 110% more light than standard lamps, the popular NIGHT BREAKER® UNLIMITED is the second most powerful OSRAM halogen light and available in most standard types.



Main benefits

- Up to 110% more light on the road¹⁾
- Up to 35 m longer beam¹⁾
- Up to 20% whiter light¹⁾
- Signs, obstacles and hazards are more rapidly recognized
- Longer reaction time
- Eye-catching design with partial blue coating and silver cap (H4/H7/H11/HB4)
- Precise filament position for better light distribution

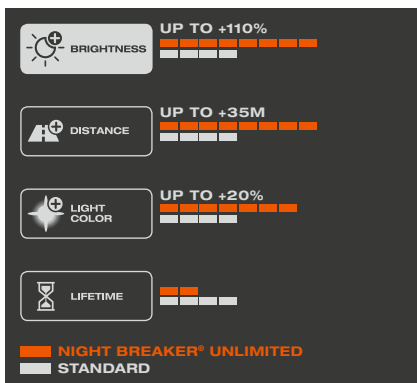



OSRAM NIGHT BREAKER® UNLIMITED product range

Product Reference	ECE	Product Number	V	W				
64150NBU	H1	4052899 016231	12	55	P14.5s	1	100	5 ^{P.116}
64150NBU-01B	H1	Page 132	12	55	P14.5s	1	10	5 ^{P.116}
64150NBU-HCB	H1	Page 132	12	55	P14.5s	2	20	5 ^{P.116}
64151NBU	H3	4052899 016323	12	55	PK22s	1	100	9 ^{P.116}
64151NBU-01B	H3	Page 132	12	55	PK22s	1	10	9 ^{P.116}
64193NBU	H4	4052899 017122	12	60/55	P43t	1	100	14 ^{P.116}
64193NBU-01B	H4	Page 132	12	60/55	P43t	1	10	14 ^{P.116}
64193NBU-HCB	H4	Page 132	12	60/55	P43t	2	20	14 ^{P.116}
64210NBU	H7	4052899 016972	12	55	PX26d	1	100	19 ^{P.116}
64210NBU-01B	H7	Page 132	12	55	PX26d	1	10	19 ^{P.116}
64210NBU-HCB	H7	Page 132	12	55	PX26d	2	20	19 ^{P.116}
64212NBU-HCB	H8	Page 132	12	35	PGJ19-1	2	20	31 ^{P.116}
64211NBU	H11	4052899 016392	12	55	PGJ19-2	1	100	29 ^{P.116}
64211NBU-01B	H11	Page 132	12	55	PGJ19-2	1	10	29 ^{P.116}
64211NBU-HCB	H11	Page 132	12	55	PGJ19-2	2	20	29 ^{P.116}
9005NBU-HCB	HB3	Page 132	12	60	P20d	2	20	36 ^{P.116}
9006NBU-HCB	HB4	Page 132	12	51	P22d	2	20	37 ^{P.116}

1) Compared with standard lamps

OSRAM SILVERSTAR® 2.0

Best price-performance ratio

With up to 60% more light than standard halogen lamps, an excellent choice for motorists with high demands for performance, safety and value for money.



Main benefits

- Up to 60% more light¹⁾
- Up to 20 m longer beam¹⁾
- Signs, obstacles and hazards are more rapidly recognized
- Longer reaction time
- Excellent price-performance ratio

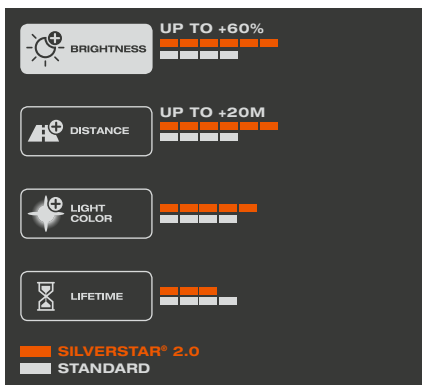



OSRAM SILVERSTAR® 2.0 product range

Product Reference	ECE	Product Number	V	W					No.
64150SV2	H1	4008321785824	12	55	P14.5s	1	100		6 ^{P.116}
64150SV2-01B	H1	Page 132	12	55	P14.5s	1	10		6 ^{P.116}
64150SV2-HCB	H1	Page 132	12	55	P14.5s	2	20		6 ^{P.116}
64193SV2	H4	4008321785930	12	60/55	P43t	1	100		13 ^{P.116}
64193SV2-01B	H4	Page 132	12	60/55	P43t	1	10		13 ^{P.116}
64193SV2-HCB	H4	Page 132	12	60/55	P43t	2	20		13 ^{P.116}
64210SV2	H7	4008321786685	12	55	PX26d	1	100		21 ^{P.116}
64210SV2-01B	H7	Page 132	12	55	PX26d	1	10		21 ^{P.116}
64210SV2-HCB	H7	Page 132	12	55	PX26d	2	20		21 ^{P.116}
64211SV2	H11	4008321787156	12	55	PGJ19-2	1	100		27 ^{P.116}
64211SV2-HCB	H11	Page 132	12	55	PGJ19-2	2	20		27 ^{P.116}

1) Compared with standard lamps

OSRAM COOL BLUE® INTENSE

Bluish-white light for xenon look

Stylish xenon look and extra safety: High-tech halogen lamp, almost in the league of xenon lamps with their powerful bluish-white light.



Main benefits

- Bluish-white light for xenon look
- Color temperatures of up to 4,200 K
- Up to 20% brighter¹⁾
- Modern design with silver cap (H4, H7, H11, H27W/1, H27W/2, HB4)
- Ideal for use in clear-glass headlights
- **W5W with color temperatures up to 3,700 K (± 200 K)**
 - More homogeneous color appearance in combination with HID-systems
 - For interior lighting/parking light/license plate illumination, interchangeable with standard bulbs

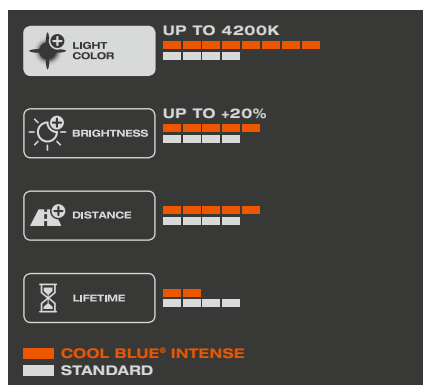



OSRAM COOL BLUE® INTENSE product range

Product Reference	ECE	Product Number	V	W				
64150CBI	H1	4008321 655325	12	55	P14.5s	1	100	7 ^{P.116}
64150CBI-01B	H1	Page 132	12	55	P14.5s	1	10	7 ^{P.116}
64150CBI-HCB	H1	Page 132	12	55	P14.5s	2	20	7 ^{P.116}
64151CBI	H3	4008321 655462	12	55	PK22s	1	100	11 ^{P.116}
64193CBI	H4	4008321 650894	12	60/55	P43t	1	100	12 ^{P.116}
64193CBI-01B	H4	Page 132	12	60/55	P43t	1	10	12 ^{P.116}
64193CBI-HCB	H4	Page 132	12	60/55	P43t	2	20	12 ^{P.116}
64210CBI	H7	4008321 651341	12	55	PX26d	1	100	20 ^{P.116}
64210CBI-01B	H7	Page 132	12	55	PX26d	1	10	20 ^{P.116}
64210CBI-HCB	H7	Page 132	12	55	PX26d	2	20	20 ^{P.116}
64212CBI-HCB	H8	Page 132	12	35	PGJ19-1	2	20	31 ^{P.116}
64211CBI	H11	4052899 433175	12	55	PGJ19-2	1	100	28 ^{P.116}
64211CBI-HCB	H11	Page 132	12	55	PGJ19-2	2	20	28 ^{P.116}
64176CBI	H15	4052899 932708	12	55/15	PGJ23t-1	1	100	24 ^{P.116}
64176CBI-HCB	H15	Page 132	12	55/15	PGJ23t-1	2	20	24 ^{P.116}
64219CBI	H16	4052899 268326	12	19	PGJ19-3	1	100	25 ^{P.116}
64219CBI-HCB	H16	Page 132	12	19	PGJ19-3	2	20	25 ^{P.116}
880CBI	H27W/1	4052899 479999	12	27	PG13	1	100	44 ^{P.117}
881CBI	H27W/2	4052899 480025	12	27	PGJ13	1	100	45 ^{P.117}
9005CBI-HCB	HB3	Page 132	12	60	P20d	2	20	34 ^{P.116}
9006CBI-HCB	HB4	Page 132	12	51	P22d	2	20	40 ^{P.116}
9012CBI	HIR2	4052899 455405	12	55	PX22d	1	100	47 ^{P.117}
2825HCBI	W5W	4008321 650849	12	5	W2.1x9.5d	10	50	81 ^{P.117}
2825HCBI-02B	W5W	Page 132	12	5	W2.1x9.5d	2	20	81 ^{P.117}

1) Compared with standard lamps, subjective perception



OSRAM DIADEM® CHROME and DIADEM®

Only amber or red during operation

Visual tuning for indicator and tail lamps: The signal lights only emit amber or red light during operation – making them the perfect, attractive light supplement for halogen and xenon headlamps.

Main benefits: DIADEM® CHROME

- Only amber when operating, otherwise almost invisible
- Chrome look thanks to cutting edge interference and absorber coating
- Exclusive design
- No irritating color effects
- Ideal for all indicator lights with clear covers

Main benefits: DIADEM®

- Lamps with amber or red light emission
- Opal look thanks to state-of-the-art interference coating
- Ideal for all indicator lights with clear covers
- Up to double the service life¹⁾

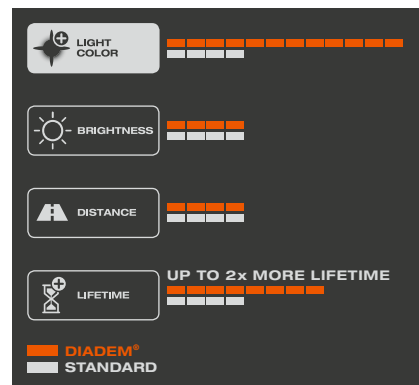
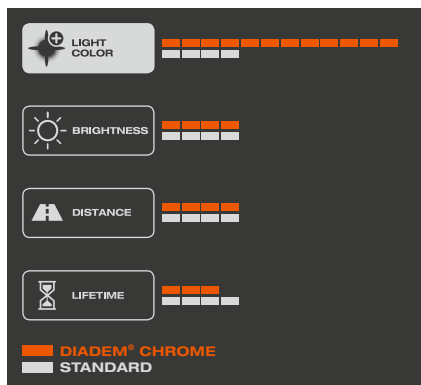



OSRAM DIADEM® CHROME product range

Product Reference	ECE	Product Number	V	W				
2827DC-02B ²⁾	WY5W	Page 132	12	5	W2.1x9.5d	2	20	66 ^{P.117}
7507DC-02B ²⁾	PY21W	Page 132	12	21	BAU15s	2	20	52 ^{P.117}

OSRAM DIADEM® product range

Product Reference	ECE	Product Number	V	W				
7507LDA ²⁾	PY21W	4008321 137418	12	21	BAU15s	10	50	56 ^{P.117}
7507LDA-02B ²⁾	PY21W	Page 132	12	21	BAU15s	2	20	56 ^{P.117}
7508LDR-01B ³⁾	PR21W	Page 132	12	21	BAW15s	1	10	56 ^{P.117}
7538LDR-01B ³⁾	PR21/5W	Page 132	12	21/5	BAW15d	1	10	60 ^{P.117}

1) Compared with standard lamps

2) Amber lamps for clear indicator lights

3) Red light for clear tail/brake lights

OSRAM ULTRA LIFE

Longer life and four-year guarantee

The improved ULTRA LIFE product family provides more driving comfort, convenience and durability. The lamps last up to four times longer compared to standard headlight lamps and have a rock-solid guarantee of four years with online registration.



Main benefits

- 4-year guarantee¹⁾
- Up to 4 times longer lifetime²⁾
- Up to 100,000 km service life³⁾
- More durability and longer replacement cycle
- Modern design with silver cap (H4/H7/H11), perfect for clearglass headlights
- Large range of headlight and auxiliary lamps

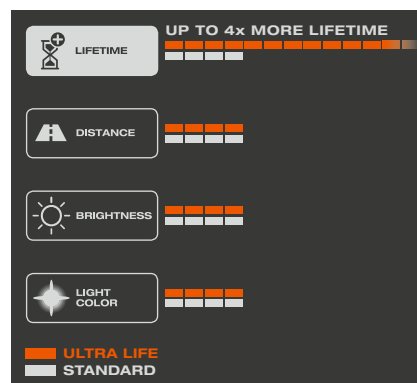



OSRAM ULTRA LIFE product range

Product Reference	ECE	Product Number	V	W				
64150ULT	H1	4008321416209	12	55	P14.5s	1	100	6 ^{P.116}
64150ULT-01B	H1	Page 132	12	55	P14.5s	1	10	6 ^{P.116}
64150ULT-HCB	H1	Page 132	12	55	P14.5s	2	20	6 ^{P.116}
64193ULT	H4	4008321416230	12	60/55	P43t	1	100	13 ^{P.116}
64193ULT-01B	H4	Page 132	12	60/55	P43t	1	10	13 ^{P.116}
64193ULT-HCB	H4	Page 132	12	60/55	P43t	2	20	13 ^{P.116}
64210ULT	H7	4008321416261	12	55	PX26d	1	100	21 ^{P.116}
64210ULT-01B	H7	Page 133	12	55	PX26d	1	10	21 ^{P.116}
64210ULT-HCB	H7	Page 133	12	55	PX26d	2	20	21 ^{P.116}
64211ULT	H11	4052899431164	12	55	PGJ19-2	1	100	27 ^{P.116}
64211ULT-01B	H11	Page 133	12	55	PGJ19-2	1	10	27 ^{P.116}
64211ULT-HCB	H11	Page 133	12	55	PGJ19-2	2	20	27 ^{P.116}
7506ULT	P21W	4008321415349	12	21	BA15s	10	50	49 ^{P.117}
7506ULT-02B	P21W	Page 133	12	21	BA15s	2	20	49 ^{P.117}
7507ULT ¹⁾	PY21W	4008321413147	12	21	BAU15s	10	50	56 ^{P.117}
7507ULT-02B ⁴⁾	PY21W	Page 133	12	21	BAU15s	2	20	56 ^{P.117}
7528ULT	P21/5W	4008321413116	12	21/5	BAY15d	10	50	53 ^{P.117}
7528ULT-02B	P21/5W	Page 133	12	21/5	BAY15d	2	20	53 ^{P.117}
2825ULT	W5W	4008321413024	12	5	W2.1x9.5d	10	50	78 ^{P.117}
2825ULT-02B	W5W	Page 133	12	5	W2.1x9.5d	2	20	78 ^{P.117}
5007ULT	R5W	4008321415370	12	5	BA15s	10	50	66 ^{P.117}
5007ULT-02B	R5W	Page 133	12	5	BA15s	2	20	66 ^{P.117}
5008ULT	R10W	4008321415400	12	10	BA15s	10	50	66 ^{P.117}
5008ULT-02B	R10W	Page 133	12	10	BA15s	2	20	66 ^{P.117}
6418ULT	C5W	4008321413086	12	5	SV8.5-8	10	50	90 ^{P.117}
6418ULT-02B	C5W	Page 133	12	5	SV8.5-8	2	20	90 ^{P.117}
64132ULT	H6W	4008321413178	12	6	BAX9s	10	50	102 ^{P.117}
64132ULT-02B	H6W	Page 133	12	6	BAX9s	2	20	102 ^{P.117}
64137ULT ⁴⁾	HY21W	4052899910256	12	21	BAW9s	10	50	90 ^{P.117}

1) 4th year with online product registration. Refer to www.osram.com/am-guarantee for precise conditions and registration

2) Compared with standard lamps | 3) With an average annual mileage of 14,259 km and 60% light on | 4) Amber lamps for clear indicator lights

OSRAM ORIGINAL LINE 12V

OEM quality

Peak performance for standard requirements, robust and cost-effective: Successfully used in millions of new cars from renowned manufacturers, whether as standard initial equipment or original spare parts.



Main benefits

- Original spare part
- Excellent value for money
- Impressive brightness and reliability







OSRAM ORIGINAL LINE 12V headlight lamps / auxiliary lamps product range





Product Reference	ECE	Product Number	V	W				
64150	H1	40503000 01487	12	55	P14.5s	1	100	6 ^{P.116}
64150-01B	H1	Page 133	12	55	P14.5s	1	10	6 ^{P.116}
64173	H2	4050300 016559	12	55	X511	1	100	8 ^{P.116}
64151	H3	4050300 01494	12	55	PK22s	1	100	10 ^{P.116}
64151-01B	H3	Page 133	12	55	PK22s	1	10	10 ^{P.116}
64193	H4	4050300 01470	12	60/55	P43t	1	100	17 ^{P.116}
64193-01B	H4	Page 133	12	60/55	P43t	1	10	17 ^{P.116}
64210	H7	4050300 332185	12	55	PX26d	1	100	22 ^{P.116}
64210-01B	H7	Page 133	12	55	PX26d	1	10	22 ^{P.116}
64212	H8	4050300 498751	12	35	PGJ19-1	1	100	30 ^{P.116}
64212-01B	H8	Page 133	12	35	PGJ19-1	1	10	30 ^{P.116}
64242 ¹⁾	H8B	400832 1055422	12	35	PGJY19-1	1	100	26 ^{P.116}
64213	H9	4050300 524368	12	65	PGJ19-5	1	100	32 ^{P.116}
64243 ¹⁾	H9B	400832 1055477	12	65	PGJY19-5	1	100	33 ^{P.116}
9145	H10	4052899 348622	12	42	PY20d	1	100	39 ^{P.116}
64211	H11	4050300 524313	12	55	PGJ19-2	1	100	27 ^{P.116}
64211-01B	H11	Page 133	12	55	PGJ19-2	1	10	27 ^{P.116}
64241 ¹⁾	H11B	400832 1054654	12	55	PGJY19-2	1	100	26 ^{P.116}
9008	H13	400832 1939401	12	60/55	P26.4t	1	10	42 ^{P.116}
64176	H15	400832 1218391	12	55/15	PGJ23t-1	1	100	24 ^{P.116}
64219L+	H16	400832 1626783	12	19	PGJ19-3	1	100	25 ^{P.116}
880	H27W/1	400832 1542977	12	27	PG13	1	100	44 ^{P.117}
881	H27W/2	400832 1543004	12	27	PGJ13	1	100	45 ^{P.117}
9005	HB3	4050300 137193	12	60	P20d	1	100	34 ^{P.116}
9005-01B	HB3	Page 133	12	60	P20d	1	10	34 ^{P.116}
9005XS	HB3A	4052899 982567	12	60	P20d	1	100	38 ^{P.116}
9006	HB4	4050300 012650	12	51	P22d	1	100	39 ^{P.116}
9006-01B	HB4	Page 133	12	51	P22d	1	10	39 ^{P.116}
9006XS	HB4A	400832 1554284	12	51	P22d	1	100	23 ^{P.116}
9007	HB5	4050300 148816	12	65/55	PX29t	1	200	41 ^{P.116}

1) New development for simple relamping and high-efficiency headlamps; supply on request

OSRAM ORIGINAL LINE 12V headlight lamps / auxiliary lamps product range

Product Reference	ECE	Product Number	V	W				
64183 ¹⁾	R2	4050300 350554	12	45/40	P45t	1	100	18 ^{P.112}
64183-01B ¹⁾	R2	Page 133	12	45/40	P45t	1	10	18 ^{P.112}
9011	HIR1	400832 1863966	12	65	PX20d	1	100	46 ^{P.117}
9012	HIR2	400832 1863997	12	55	PX22d	1	100	46 ^{P.117}
7506	P21W	4050300 838120	12	21	BA15s	10	50	49 ^{P.117}
7506-02B	P21W	Page 133	12	21	BA15s	2	20	49 ^{P.117}
7507 ²⁾	PY21W	4050300 891477	12	21	BAU15s	10	50	56 ^{P.117}
7507-02B ²⁾	PY21W	Page 133	12	21	BAU15s	2	20	56 ^{P.117}
7225	P21/4W	4050300 891514	12	21/4	BAZ15d	10	50	53 ^{P.117}
7225-02B	P21/4W	Page 133	12	21/4	BAZ15d	2	20	53 ^{P.117}
7240	-	4050300 838007	12	21/5	BA15d	10	50	53 ^{P.117}
7528	P21/5W	4050300 838069	12	21/5	BAY15d	10	50	53 ^{P.117}
7528-02B	P21/5W	Page 133	12	21/5	BAY15d	2	20	53 ^{P.117}
3860	-	400832 1095756	12	5	BA9s	10	50	103 ^{P.117}
3893	T4W	4050300 838489	12	4	BA9s	10	50	104 ^{P.117}
3893-02B	T4W	Page 133	12	4	BA9s	2	20	104 ^{P.117}
2820	-	400832 1094094	12	2	W2.1x9.5d	10	50	78 ^{P.117}
2821	W3W	4050300 838663	12	3	W2.1x9.5d	10	50	78 ^{P.117}
2821-02B	W3W	Page 133	12	3	W2.1x9.5d	2	20	78 ^{P.117}
2825	W5W	4050300 838632	12	5	W2.1x9.5d	10	50	78 ^{P.117}
2825-02B	W5W	Page 133	12	5	W2.1x9.5d	2	20	78 ^{P.117}
2827 ²⁾	WY5W	4052899 148000	12	5	W2.1x9.5d	10	50	82 ^{P.117}
2827-02B ²⁾	WY5W	Page 133	12	5	W2.1x9.5d	2	20	82 ^{P.117}
2886X	-	400832 1094667	12	6	W2.1x9.5d	10	50	78 ^{P.117}
921	W16W	400832 1100948	12	16	W2.1x9.5d	10	50	85 ^{P.117}
921-02B	W16W	Page 133	12	16	W2.1x9.5d	2	20	85 ^{P.117}
921NA ³⁾	WY16W	4052899 230460	12	16	W2.1x9.5d	10	50	88 ^{P.117}
7504 ³⁾	WY21W	400832 1165473	12	21	WX3x16d	10	50	75 ^{P.117}
7505	W21W	4052899 324244	12	21	W3x16d	10	50	72 ^{P.117}
7505-02B	W21W	Page 133	12	21	W3x16d	2	20	72 ^{P.117}
7515	W21/5W	4052899 324312	12	21/5	W3x16q	10	50	69 ^{P.117}
7515-02B	W21/5W	Page 133	12	21/5	W3x16q	2	20	69 ^{P.117}
2721	-	4050300 838540	12	1.2	W2x4.6d	10	50	84 ^{P.117}
2721-02B	-	Page 133	12	1.2	W2x4.6d	2	20	84 ^{P.117}
2722	-	400832 1094803	12	2	W2x4.6d	10	50	84 ^{P.117}

OSRAM ORIGINAL LINE 12V headlight lamps / auxiliary lamps product range

Product Reference	ECE	Product Number	V	W				 No.
2722-02B	-	Page 133	12	2	W2x4.6d	2	20	84 ^{P.117}
2723	W2.3W	4008321094834	12	2.3	W2x4.6d	10	50	84 ^{P.117}
64132	H6W	4008321094896	12	6	BAX9s	10	50	102 ^{P.117}
64136	H21W	4008321095190	12	21	BAY9s	10	50	89 ^{P.117}
5007	R5W	4050300838427	12	5	BA15s	10	50	66 ^{P.117}
5007-02B	R5W	Page 133	12	5	BA15s	2	20	66 ^{P.117}
5008	R10W	4050300838212	12	10	BA15s	10	50	66 ^{P.117}
5008-02B	R10W	Page 133	12	10	BA15s	2	20	66 ^{P.117}
5009 ²⁾	RY10W	4008321095442	12	10	BAU15s	10	50	67 ^{P.117}
6411	-	4050300891354	12	10	SV8.5-8	10	50	97 ^{P.117}
6411-02B	-	Page 133	12	10	SV8.5-8	2	20	97 ^{P.117}
64111 ³⁾	-	4008321095015	12	5	BA9s	10	50	101 ^{P.117}
64113	-	4008321095046	12	10	BA9s	10	50	89 ^{P.117}
64115	-	4008321095077	12	20	BA9s	10	50	101 ^{P.117}
6413	-	4050300891439	12	5	SV8.5-8	10	50	98 ^{P.117}
6418	C5W	4050300838397	12	5	SV8.5-8	10	50	91 ^{P.117}
6418-02B	C5W	Page 133	12	5	SV8.5-8	2	20	91 ^{P.117}
6438	-	4008321094353	12	10	SV8.5-8	10	50	95 ^{P.117}
6438-02B	-	Page 133	12	10	SV8.5-8	2	20	95 ^{P.117}
6461	-	4008321094261	12	10	SV8.5-8	10	50	91 ^{P.117}
6428	-	4008321094384	12	3	SV7-8	10	50	94 ^{P.117}
2351MFX6	-	4008321096852	12	1.2	BX8.4d	10	50	106 ^{P.117}
2352MFX6	-	4008321097149	12	2	BX8.4d	10	50	106 ^{P.117}
2431MFX6	-	4008321298713	12	1.3	BX8.4d	10	50	106 ^{P.117}
2452MFX6	-	4008321097118	12	1.5	BX8.4d	10	50	106 ^{P.117}
2473MFX6	-	4008321096821	12	1.12	BX8.4d	10	50	106 ^{P.117}
2721MFX	-	4008321297150	12	1.2	BX8.5d	10	50	107 ^{P.117}
2722MFX	-	4008321297181	12	2	BX8.5d	10	50	107 ^{P.117}
2721MF	-	4050300891255	12	1.2	B8.5d	10	50	107 ^{P.117}
2722MF	-	4008321096791	12	2	B8.5d	10	50	107 ^{P.117}
3156	P27W	4008321090621	12	27	W2.5x16d	10	50	61 ^{P.117}
3157	P27/7W	4052899183414	12	27/7	W2.5x16q	10	50	62 ^{P.117}
3757AK ²⁾	PY27/7W	4052899178731	12	27/7	W2.5x16q	10	50	65 ^{P.117}
3796	-	4050300891309	12	2	Ba9s	10	50	103 ^{P.117}

1) Successor type for BILUX®-AS® lamp (product reference 7951)

2) Amber lamps for clear indicator lights

3) Also available with glass base (product reference 6411150 or 6411350)

The suffix on the product reference indicates the board thickness:

MF6: 1.5mm

MF: 2.0mm

MF6: 1.5mm



Halogen lamps for motorcycles and scooters – safety first

Motorcycles, mopeds, or scooters are all too often overlooked in traffic – especially at night. The right lighting can save lives. Drivers of motorised two-wheelers value OSRAM motorcycle lamps for their high performance and high vibration resistance proven in tests. OSRAM halogen headlight lamps optimise illumination on the roads and provide more reaction time in the event of an emergency. Alongside increased safety, OSRAM offers bikers with motorcycle lamps a wide variety of customisation options from the design, performance, and original portfolio.



OSRAM motorcycle lamps

Vibration-resistant technology

Power and emotion, for relaxed cruisers and sportive riders: With NIGHT RACER® 110, NIGHT RACER® 90, NIGHT RACER® 50, X-RACER® and ORIGINAL, OSRAM offers a wide range of high performance motorcycle lamps – opening a new dimension for life on two wheels.



Main benefits of NIGHT RACER® 110

- Vibration-resistant technology
- Up to 110% more light on the road¹⁾
- Up to 35 m longer light beam¹⁾
- Up to 20% whiter light¹⁾
- Eye-catching design with partial blue coating and silver cap

Main benefits of NIGHT RACER® 90

- Vibration-resistant technology
- Up to 90% more light on the road¹⁾
- Up to 30 m longer light beam¹⁾
- Up to 10% whiter light¹⁾
- Eye-catching design with partial blue coating and silver cap

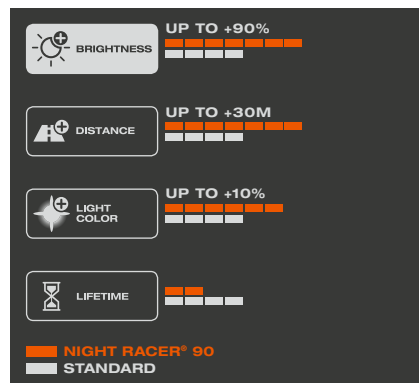
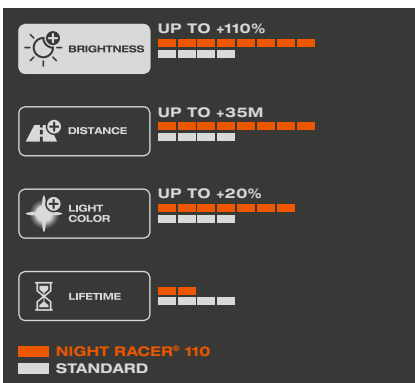



OSRAM NIGHT RACER® 110 product range

Product Reference	ECE	Product Number	V	W				
64193NR1-01B	H4	Page 133	12	60/55	P43t	1	10	14 ^{P.116}
64193NR1-02B	H4	4052899 929678	12	60/55	P43t	2	20	14 ^{P.116}
64210NR1-01B	H7	Page 133	12	55	PX26d	1	10	19 ^{P.116}
64210NR1-02B	H7	4052899 929616	12	55	PX26d	2	20	19 ^{P.116}
64212NR1-01B	H8	Page 133	12	35	PGJ19-1	2	20	30 ^{P.116}
64211NR1-01B	H11	Page 133	12	55	PGJ19-2	1	10	29 ^{P.116}

OSRAM NIGHT RACER® 90 product range

Product Reference	ECE	Product Number	V	W				
64185NR9-01B	HS1	Page 133	12	35/35	PX43t	1	10	14 ^{P.116}

1) Compared with standard lamps



Main benefits

- Vibration-resistant technology
- Up to 50% more light¹⁾
- Up to 20 m longer beam¹⁾
- Modern design with silver cap
- Excellent value for money

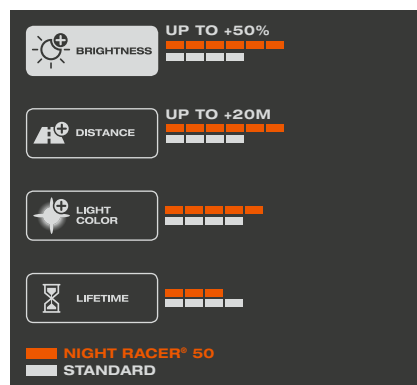



OSRAM NIGHT RACER® 50 product range

Product Reference	ECE	Product Number	V	W				
64193NR5-01B	H4	Page 133	12	60/55	P43t	1	10	16 ^{P.116}
64210NR5-01B	H7	Page 133	12	55	PX26d	1	10	21 ^{P.116}
64211NR5-01B	H11	Page 133	12	55	PGJ19-2	1	10	29 ^{P.116}
64185NR5-01B	HS1	Page 133	12	35/35	PX43t	1	10	16 ^{P.116}
64185NR5	HS1	4052899 933002	12	35/35	PX43t	1	10	16 ^{P.116}

1) Compared with standard lamps



Main benefits of X-RACER®

- Vibration-resistant technology
- Bluish-white light for xenon look
- Color temperatures of up to 4,200 K
- Up to 20% more light¹⁾
- Bright, convenient light for drivers
- Modern design with silver cap

Main benefits of ORIGINAL

- OEM quality
- Excellent value for money
- Impressive brightness
- Up to four times longer service life and no blackening (S1/S2)¹⁾

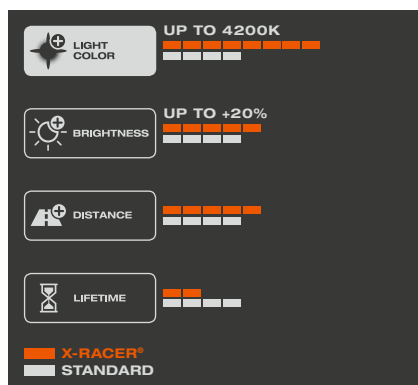



OSRAM X-RACER® product range

Product Reference	ECE	Product Number	V	W				
64193XR-01B	H4	Page 133	12	60/55	P43t	1	20	15 ^{P.116}
64193XR-02B	H4	4052899 929630	12	60/55	P43t	2	20	15 ^{P.116}
64210XR-01B	H7	Page 134	12	55	PX26d	1	20	20 ^{P.116}
64210XR-02B	H7	4052899 929579	12	55	PX26d	2	20	20 ^{P.116}
64212XR-01B	H8	Page 134	12	35	PGJ19-1	1	10	31 ^{P.116}
64211XR-01B	H11	Page 134	12	55	PGJ19-2	1	10	28 ^{P.116}
64185XR-01B	HS1	Page 134	12	35/35	PX43t	1	10	15 ^{P.116}
64327XR-01B	S2	Page 134	12	35/35	BA20d	1	10	48 ^{P.117}

OSRAM ORIGINAL product range

Product Reference	ECE	Product Number	V	W				
64193MC	H4	4052899 451353	12	60/55	P43t	1	20	15 ^{P.116}
64210MC	H7	4052899 451384	12	55	PX26d	1	20	20 ^{P.116}
64326	S1	4052899 157774	12	25/25	BA20d	1	100	48 ^{P.117}
64327	S2	4052899 136755	12	35/35	BA20d	1	100	48 ^{P.117}
64327-01B	S2	Page 134	12	35/35	BA20d	1	10	48 ^{P.117}
64185	HS1	4050300 439969	12	35/35	PX43t	1	100	17 ^{P.116}

1) Compared with standard lamps

Halogen lamps for buses and trucks – extreme durability, extreme high-performance

Truck and commercial vehicle lamps in daily use are often pushed to their performance limit. Lighting systems must therefore be enormously durable and extremely reliable – only then they can provide perfect light until the end of each run. The extremely long life of OSRAM high performance solutions enhances driving comfort and reduces maintenance time and fleet costs.

Vehicle drivers and fleet managers can choose from a wide range of high performance truck lamps at OSRAM. All lighting solutions not only meet the highest quality requirements and offer OEM quality, but also exceed even European standards.



OSRAM TRUCKSTAR® PRO

Brightest OSRAM truck light

Up to 100% more light than standard lamps, extremely long life and very high vibration resistance are ideal for professional drivers while reducing downtime and fleet costs.



Main benefits

- Up to 100% more light¹⁾
- More than double the service life¹⁾
- Improved road illumination
- Excellent value for money
- Impressive brightness and reliability
- Suitable for heavy-duty applications thanks to very high vibration resistance

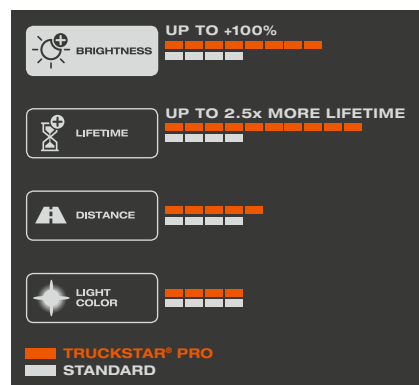



OSRAM TRUCKSTAR® PRO product range

Product Reference	ECE	Product Number	V	W				
64155TSP	H1	4008321784179	24	70	P14.5s	1	100	6 ^{P.116}
64155TSP-HCB	H1	Page 134	24	70	P14.5s	2	20	6 ^{P.116}
64156TSP	H3	4008321784261	24	70	PK22s	1	100	10 ^{P.116}
64156TSP-01B	H3	Page 134	24	70	PK22s	1	10	10 ^{P.116}
64196TSP	H4	4008321785046	24	75/70	P43t	1	100	17 ^{P.116}
64196TSP-HCB	H4	Page 134	24	75/70	P43t	2	20	17 ^{P.116}
64215TSP	H7	4008321785114	24	70	PX26d	1	100	22 ^{P.116}
64215TSP-HCB	H7	Page 134	24	70	PX26d	2	20	22 ^{P.116}
64216TSP	H11	4052899904804	24	70	PGJ19-2	1	100	27 ^{P.116}
64216TSP-HCB	H11	Page 134	24	70	PGJ19-2	2	20	27 ^{P.116}
7510TSP ²⁾	PY21W	4008321798169	24	21	BAU15s	10	50	56 ^{P.117}
7511TSP	P21W	4052899340459	24	21	BA15s	10	50	52 ^{P.117}
7537TSP	P21/5W	4008321798138	24	21/5	BAY15d	10	50	53 ^{P.117}
2845TSP	W5W	4008321798077	24	5	W2.1x9.5d	10	50	78 ^{P.117}
5627TSP	R5W	4008321795151	24	5	BA15s	10	50	68 ^{P.117}
5637TSP	R10W	4008321795205	24	10	BA15s	10	50	68 ^{P.117}
3930TSP	T4W	4008321795106	24	4	BA9s	10	50	104 ^{P.117}
3930TSP-02B	T4W	Page 134	24	4	BA9s	2	20	104 ^{P.117}

1) Compared with standard lamps

2) Amber lamps for clear indicator lights

OSRAM ORIGINAL LINE 24V

OEM quality for trucks

Continuously safe and reliable: A balanced and economic solution for all standard requirements in the 24V sector. Successfully used in millions of new vehicles from renowned manufacturers, whether as standard initial equipment or original spare parts.



Main benefits

- Original spare part
- Excellent value for money
- Impressive brightness and reliability

The suffix on the product reference indicates the board thickness:

MF: 2.0 mm

MFX: 1.5 mm



OSRAM ORIGINAL LINE 24V headlight lamps / auxiliary lamps product range

Product Reference	ECE	Product Number	V	W					No.
64155	H1	4050300016498	24	70	P14.5s	1	100	6 ^{P.116}	
64155-01B	H1	Page 134	24	70	P14.5s	1	10	6 ^{P.116}	
64175	H2	4050300218960	24	70	X511	1	100	8 ^{P.116}	
64156	H3	4050300016535	24	70	PK22s	1	100	10 ^{P.116}	
64156-01B	H3	Page 134	24	70	PK22s	1	10	10 ^{P.116}	
64196	H4	4050300016542	24	75/70	P43t	1	100	17 ^{P.116}	
64196-01B	H4	Page 134	24	75/70	P43t	1	10	17 ^{P.116}	
94196	H4	4050300250632	24	75/70	P43t	1	100	17 ^{P.116}	
64215	H7	4050300386522	24	70	PX26d	1	100	22 ^{P.116}	
64215-01B	H7	Page 134	24	70	PX26d	1	10	22 ^{P.116}	
64177	H15	4008321536556	24	20/60	PGJ23t-1	1	100	24 ^{P.116}	
7511	P21W	4050300838090	24	21	BA15s	10	50	52 ^{P.117}	
7511-02B	P21W	Page 134	24	21	BA15s	2	20	52 ^{P.117}	
7537	P21/5W	4050300838038	24	21/5	BAY15d	10	50	53 ^{P.117}	
7537-02B	P21/5W	Page 134	24	21/5	BAY15d	2	20	53 ^{P.117}	
7529	-	4050300891774	24	15	BA15s	10	50	49 ^{P.117}	
5626	R5W	4008321095336	24	5	BA15d	10	50	68 ^{P.117}	
5627	R5W	4050300838335	24	5	BA15s	10	50	68 ^{P.117}	
5627-02B	R5W	Page 134	24	5	BA15s	2	20	68 ^{P.117}	
5637	R10W	4050300831459	24	10	BA15s	10	50	68 ^{P.117}	
5637-02B	R10W	Page 134	24	10	BA15s	2	20	68 ^{P.117}	
3930	T4W	4050300838366	24	4	BA9s	10	50	104 ^{P.117}	
3930-02B	T4W	Page 134	24	4	BA9s	2	20	104 ^{P.117}	
64138	H21W	4008321094988	24	21	BAY9s	10	50	89 ^{P.117}	
2341	-	4008321132529	24	1	W2x4.6d	10	50	78 ^{P.117}	
2840	-	4008321094698	24	2	W2.1x9.5d	10	50	78 ^{P.117}	
2841	W3W	4008321094728	24	3	W2.1x9.5d	10	50	78 ^{P.117}	
2841-02B	W3W	Page 134	24	3	W2.1x9.5d	2	20	78 ^{P.117}	
2845	W5W	4050300891552	24	5	W2.1x9.5d	10	50	78 ^{P.117}	
2845-02B	W5W	Page 134	24	5	W2.1x9.5d	2	20	78 ^{P.117}	
2741	-	4050300838519	24	1.2	W2x4.6d	10	50	84 ^{P.117}	
6421	-	4008321090768	24	3	SV8.5-8	10	50	98 ^{P.117}	
6423	C5W	4050300831435	24	5	SV8.5-8	10	50	91 ^{P.117}	
6423-02B	C5W	Page 134	24	5	SV8.5-8	2	20	91 ^{P.117}	
6424	-	4050300891712	24	5	SV8.5-8	10	50	98 ^{P.117}	
6429	-	4008321090836	24	10	SV8.5-8	10	50	98 ^{P.117}	
6430	-	4008321094414	24	3	SV8.5-8	10	50	94 ^{P.117}	
2741MF	-	4050300891606	24	1.2	B8.5d	10	50	107 ^{P.117}	
2741MFX	-	4008321297211	24	1.2	BX8.5d	10	50	107 ^{P.117}	



Lamps for off-road use – best light, even off-road¹⁾

Whether for emergency services, construction and transport work, agriculture and forestry, or an enthusiast off roader, driving off-road demands everything of lighting systems. Thanks to many years of experience in off-road driving, OSRAM knows exactly what these drivers want. In addition to robustness, resistance, and stability, above all they want outstanding and reliable lighting performance. The answer is a strong OSRAM product range of off-road lamps with high wattage that impress with excellent brightness and high color temperature in absolutely any environment.

¹⁾ These products do not have ECE approval. This means that they cannot be fitted in “normal” headlights or additional headlights if the vehicle is to be used on public roads.

SUPER BRIGHT PREMIUM / SUPER BRIGHT

Extra power for off-road use





With a strong portfolio of high-wattage off-road lamps with extra power, OSRAM provides solutions for even the most unusual requirements. All lamps are designed and designated for off-road use only and not permitted on public roads¹⁾.



Main benefits of SUPER BRIGHT/PREMIUM¹⁾

- Rugged and versatile
- Excellent brightness even on the most difficult terrain: rescue services, construction and transport work, agriculture and forestry
- SUPER BRIGHT PREMIUM:
 - assortment with all standard base types
- SUPER BRIGHT:
 - assortment with special base types
- Please note: These lamps are not approved for use on public roads. Use on public roads leads to cancellation of operating license and loss of insurance coverage

OSRAM SUPER BRIGHT PREMIUM / SUPER BRIGHT high-performance headlamps¹⁾ – product range

Product Reference	Product Number	V	W				 No.
62200SBP	4052899 126282	12	100	P14.5s	1	100	6 ^{P.116}
62201SBP	4052899 126312	12	100	PK22s	1	100	10 ^{P.116}
62204SBP	400832 1856357	12	100/90	P43t	1	100	17 ^{P.116}
62261SBP	400832 1856388	12	80	PX26d	1	100	22 ^{P.116}
69005SBP	400832 1888174	12	100	P20d	1	100	33 ^{P.116}
69006SBP	400832 1888228	12	80	P22d	1	100	38 ^{P.116}
64152SB	4050300 222738	12	100	PX14.5s	1	100	6 ^{P.116}
64153SB	4050300 222837	12	100	PKY22s	1	100	10 ^{P.116}
64194SB	4050300 225852	12	100/90	PU43t	1	100	17 ^{P.116}
64204SB	4052899 931565	12	100/90	P45t	1	100	17 ^{P.116}
64198SB	4050300 222028	12	60/55	P45t	1	100	18 ^{P.116}

1) These products do not have ECE approval. This means they must not be used on public roads.

XENARC® COOL BLUE® BOOST / COOL BLUE® BOOST

Hyper blue light for off-road use

The COOL BLUE® BOOST and XENARC® COOL BLUE® BOOST product families convince with hyper blue light and high color temperatures. All lamps are designed and designated for off-road use only and not permitted on public roads¹⁾.



Main benefits of XENARC® COOL BLUE® BOOST¹⁾

- Hyper blue light (from a special filling system instead of conventional coating)
- Color temperatures up to 7,000 K
- Please note: These lamps are not approved for use on public roads. Use on public roads leads to cancellation of operating license and loss of insurance coverage

Main benefits of COOL BLUE® BOOST¹⁾

- Hyper blue light
- Color temperatures up to 5,000 K
- Up to 50% more light (compared to other blue coated halogen lamps)
- Please note: These lamps are not approved for use on public roads. Use on public roads leads to cancellation of operating license and loss of insurance coverage

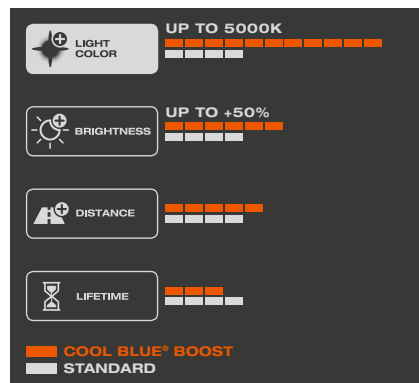
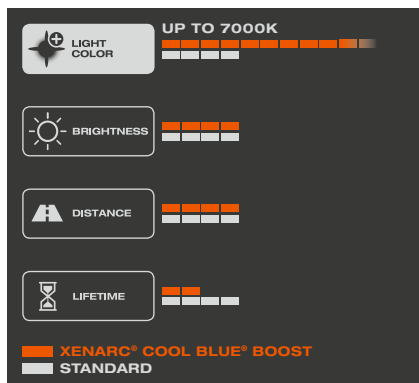



Available soon

OSRAM XENARC® COOL BLUE® BOOST high-performance headlamps¹⁾ – product range

Product Reference	Product Number	V	W				
66140CBB-HCB	Page 132	12/24	35	PK32d-2	2	10	1 ^{P.116}
66240CBB-HCB	Page 132	12/24	35	P32d-2	2	10	3 ^{P.116}
66340CBB-HCB	Page 132	12/24	35	PK32d-5	2	10	1 ^{P.116}
66440CBB-HCB	Page 132	12/24	35	P32d-5	2	10	3 ^{P.116}

OSRAM COOL BLUE® BOOST high-performance headlamps¹⁾ – product range

Product Reference	Product Number	V	W				
62150CBB-HCB	Page 134	12	80	P14.5s	2	20	7 ^{P.116}
62193CBB-HCB	Page 134	12	100/90	P43t	2	20	15 ^{P.116}
62210CBB-HCB	Page 134	12	80	PX26d	2	20	20 ^{P.116}
62211CBB-HCB	Page 134	12	75	PGJ19-2	2	20	28 ^{P.116}
62213CBB-HCB	Page 134	12	75	PGJ19-5	2	20	35 ^{P.116}
69005CBB-HCB	Page 134	12	100	P20d	2	20	34 ^{P.116}
69006CBB-HCB	Page 134	12	80	P22d	2	20	40 ^{P.116}

1) These products do not have ECE approval. This means they must not be used on public roads.

Sets and tools for all requirements – practical support in everyday life

As part of its holistic approach to products and marketing, OSRAM provides a large number of sets and tools to ensure the best possible support on the road and an attractive product presentation. Spare lamp kits make lamp replacement on the way possible. For retail outlets, filling stations and workshops practical lamp depots are available. High-quality displays and demonstration tools present and demonstrate products in a clear way, and with clear information. Your requirements are as unique as our OSRAM solutions.



OSRAM MINIBOX

Mobile lamp replacement

Defects in a vehicle usually make themselves known on long journeys. The OSRAM MINIBOX saves you the trouble of searching for a suitable workshop to purchase replacement lamps. You can therefore easily fix the problem yourself.



Main benefits

- With the lamp kit you'll always have the right spare lamps to hand
- Easy identification with clear labeling and application illustration
- Mandatory in many countries

OSRAM MINIBOX product range



H1 box

The H1 box is equipped with one H1 headlight lamp and contains the following five most important spare lamps and three flat fuses.

Product Number: 4050300875217

Product Reference ECE i

64150	H1	Headlight
7506	P21W	Brake and tail light
7507	PY21W	Indicator light, amber
7528	P21/5W	Brake/tail light
5007	R5W	Tail light and numberplate light
2825	W5W	Parking light
		15 A, 20 A, 30 A flat fuses



H4 box

The H4 box is equipped with one H4 headlight lamp and contains the following five most important spare lamps and three flat fuses.

Product Number: 4050300873398

Product Reference ECE i

64193	H4	Headlight
7506	P21W	Brake and tail light
7507	PY21W	Indicator light, amber
7528	P21/5W	Brake/tail light
5007	R5W	Tail light and numberplate light
2825	W5W	Parking light
		15 A, 20 A, 30 A flat fuses



H7 box

The H7 box is equipped with one H7 headlight lamp and contains the following five most important spare lamps and three flat fuses.

Product Number: 4050300876375

Product Reference ECE i

64210	H7	Headlight
7506	P21W	Brake and tail light
7507	PY21W	Indicator light, amber
7528	P21/5W	Brake/tail light
5007	R5W	Tail light and numberplate light
2825	W5W	Parking light
		15 A, 20 A, 30 A flat fuses

OSRAM spare lamp kit 24V

Reserve light for trucks and buses

Professional truck drivers in particular rely on spare lamp kits from OSRAM. They can be used to repair faults without assistance or major work, wherever required.



Main benefits

- With the spare lamp kits you've always got the right spare lamps to hand
- Easy identification with clear labeling and application illustration

OSRAM spare lamp box, 24 V range

H7 TRUCKSTAR® PRO box

The TRUCKSTAR® PRO box is equipped with two H7 TRUCKSTAR® PRO headlight lamps and contains the following double sets of the six most important spare lamps and three flat fuses.

Product Number: 4008321809063

Product Reference **ECE** **i**

64215TSP	H7	Headlight
7511TSP	P21W	Brake and tail light
7510TSP	PY21W	Indicator light, amber
7537TSP	P21/5W	Brake/tail light
5627TSP	R5W	Tail light and numberplate light
5637TSP	R10W	Parking light
3930TSP	T4W	Park and position light
		15A, 20A, 30A flat fuses

H4 ORIGINAL box

The H4 box is equipped with two H4 headlight lamps and contains the following double sets of the six most important spare lamps and three flat fuses.

Product Number: 4008321583192

Product Reference **ECE** **i**

64196	H4	Headlight
7511	P21W	Brake and tail light
7510TSP	PY21W	Indicator light, amber
7537	P21/5W	Brake/tail light
5627	R5W	Tail light and numberplate light
5637	R10W	Parking light
3930	T4W	Park and position light
		15A, 20A, 30A flat fuses

H7 ORIGINAL box

The H7 box is equipped with two H7 headlight lamps and contains the following double sets of the six most important spare lamps and three flat fuses.

Product Number: 4008321583215

Product Reference **ECE** **i**

64215	H7	Headlight
7511	P21W	Brake and tail light
7510TSP	PY21W	Indicator light, amber
7537	P21/5W	Brake/tail light
5627	R5W	Tail light and numberplate light
5637	R10W	Parking light
3930	T4W	Park and position light
		15A, 20A, 30A flat fuses



OSRAM Automotive lamp cabinet

Perfect order for easy access

Robust construction, individual stocking: The ALC offers clear and easy access to the OSRAM 12 volt or 24 volt product range.



Main benefits

- Clear lamp arrangement
- Slot system for easy removal
- Drawers for additional lamps
- Lamp tester optionally available
- Available with or without lock

OSRAM Automotive lamp cabinet

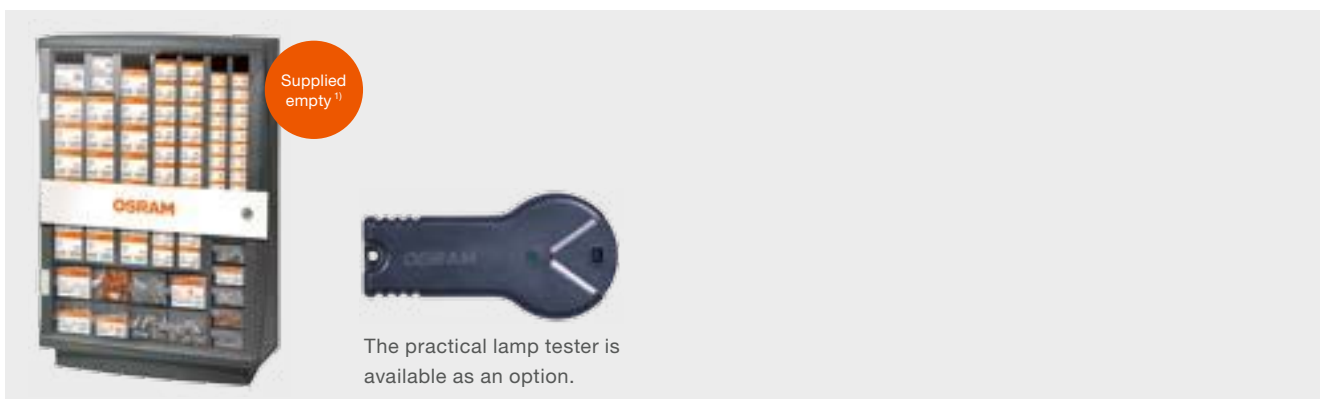

Product Reference	Product Number	Dimensions (W x H x D)
ALC without ¹⁾	4008321 694355	405 x 572 x 190 mm
ALC with lock ¹⁾	4008321 694362	405 x 572 x 190 mm
Lamp tester 50X1	4008321 786951	-

1) We are happy to provide you with a proposal of stock. Please contact your local representative.

OSRAM workshop helpers

Practical at work and for the POS

The easy-to-use Shelf Rack provides space for the most important passenger car or truck lamps from OSRAM. The robust assortment box allows quick, mobile access to the most frequently required MINIWATT® lamps for passenger cars.



Main benefits of Shelf Rack

- Row of hooks for presenting blister packs, DUO BOXES, new products
- Ideal for workshops and filling stations, practical for everyday use
- High-quality material and eye-catching design, ideal OSRAM in-store placement

Main benefits of MINIWATT® 12V assortment box

- 18 different MINIWATT® 12V lamps for passenger cars (total of 180 lamps), highlighted in color
- Equipment overview with the most important technical data directly in the box

OSRAM Shelf Rack

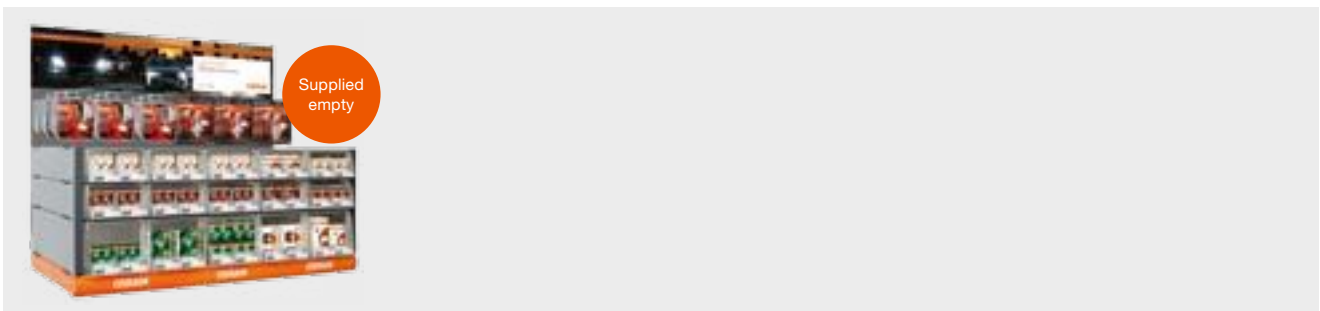

Product Reference	Product Number	Dimensions (W x H x D)
SHELF RACK	4008321211248	920 x 900 x 580 mm

OSRAM MINIWATT® 12V

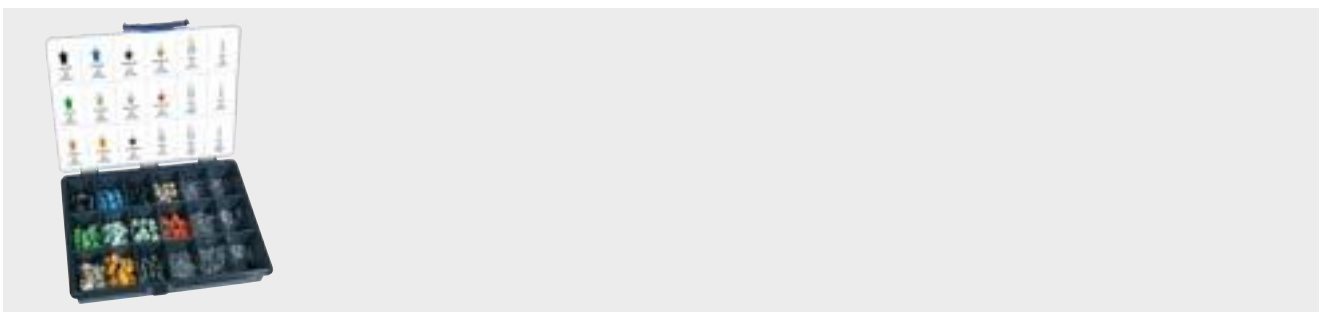

Product Reference	Product Number	Dimensions (W x H x D)	Contents	
509961	4008321082169	240 x 43 x 190 mm	180 lamps	3

OSRAM Automotive demo tools

Boost your customer's sales experience

Various types of OSRAM Automotive demo tools provide customers with opportunities to experience the wide range of product technologies at the point of sale. These tools not only portray all USPs but also allow your customer to test and compare different technologies, find the right product more easily and thus increase your sale.



Main benefits of OSRAM demo tools

- Demonstrates multiple technologies
- Enables direct product comparison
- Test-me feature
- Real-life experience
- Easy to handle

Demonstration tools



Product Reference	Product Number	Dimensions (W x H x D)
Halogen DEMOTOOL	4052899371620	348 x 338 x 254 mm
Xenon DEMOTOOL	4052899373914	348 x 338 x 254 mm

Demonstration tools

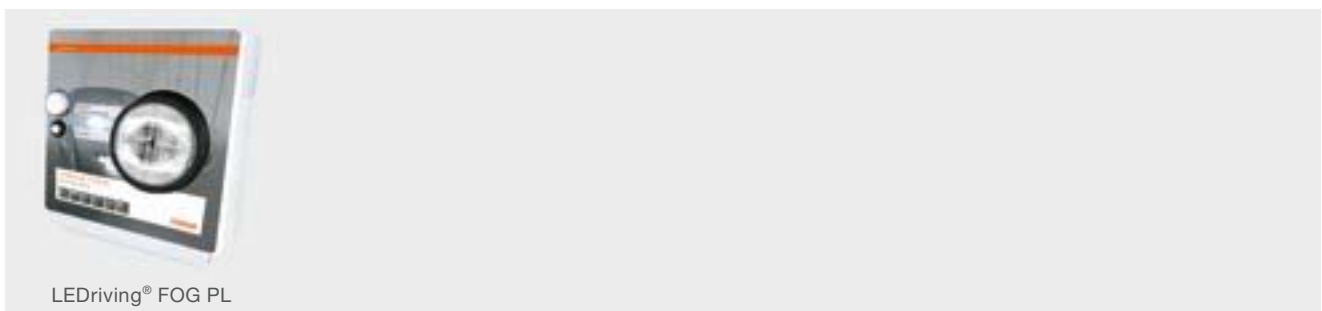

Product Reference	Product Number	Dimensions (W x H x D)
LEDDriving® FOG PL	4052899384347	205 x 230 x 140 mm

OSRAM polePOStion® & displays

Convincing product presentation

Attract customer attention with OSRAM's eye-catching instore solutions portfolio. From secondary placements up to a brand new shelf system, OSRAM's range of assortments stands out and shows all products at a glance. With the perfect tool for every type of merchandising solution you may need, OSRAM is your ideal partner.



Main benefits of OSRAM Automotive polePOStion®

- Ideal and innovative construction mirroring the OSRAM portfolio segmentation
- Flexible, modern design for easy adaptation
- High-quality and extremely convenient presentation system
- Variable construction according to every store's requirements

Main benefits of OSRAM displays

- Perfect product presentation
- Compact and eye-catching design
- High-quality and practical construction



Please contact your responsible account manager if you are interested in our OSRAM Automotive polePOSITION® and the new display designs. All order numbers of the individual elements can be found at the bottom of this page.

OSRAM Automotive polePOSITION®

Automotive polePOSITION® and Presentation Tools



Revolving Counter Display

Revolving Floor Display

Counter Display NIGHT BREAKER® LASER

Product Reference	Product Number	Dimensions (W x H x D)	Content
Revolving Counter Display	4052899518360	491 x 284 x 284 mm	-
Revolving Floor Display	4052899518377	1541 x 380 x 380 mm	-
Counter Display NIGHT BREAKER® LASER	page 131	297 x 310 x 340 mm	Assortment of H4 & H7
Header with illumination – 1.0m	4052899518384	186 x 444 x 996 mm	-
Header with illumination – 1.25m	4052899518391	186 x 444 x 1246 mm	-
Header without illumination - 0.9m	4052899518421	45 x 470 x 896 mm	-
Header without illumination - 1.0m	4052899518407	45 x 470 x 996 mm	-
Header without illumination – 1.25m	4052899518414	45 x 470 x 1246 mm	-
Side Board Fixture	4052899518452	38 x 1400 x 30 mm	-
Orange Frame	4052899518445	175 x 950 x 475 mm	-
Demo Tool Board Small	4052899519589	261 x 90 x 220 mm	-
Demo Tool Board Large	4052899519572	261 x 90 x 475 mm	-
Flyer Holder	4052899518438	153 x 172 x 110 mm	-

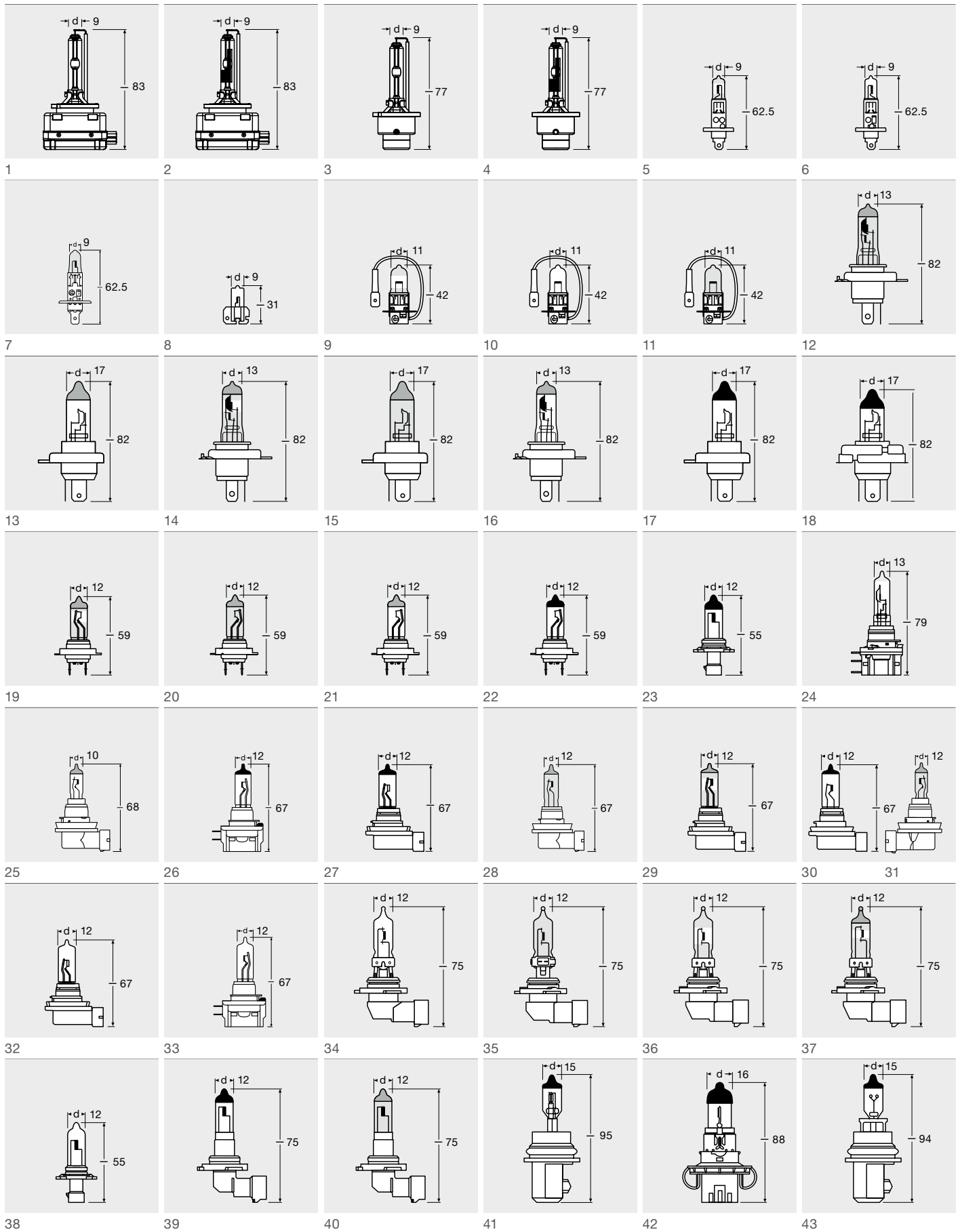

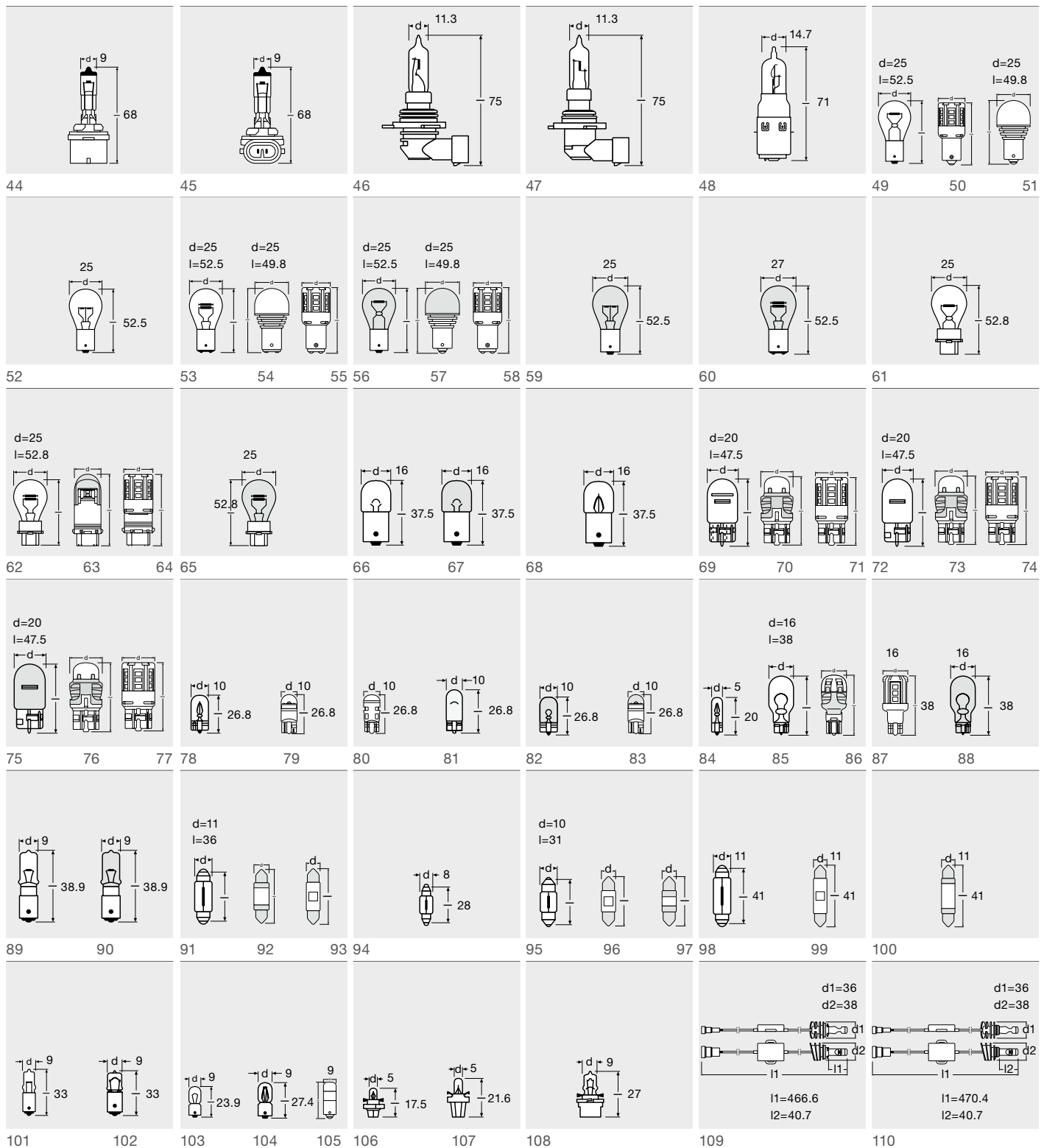

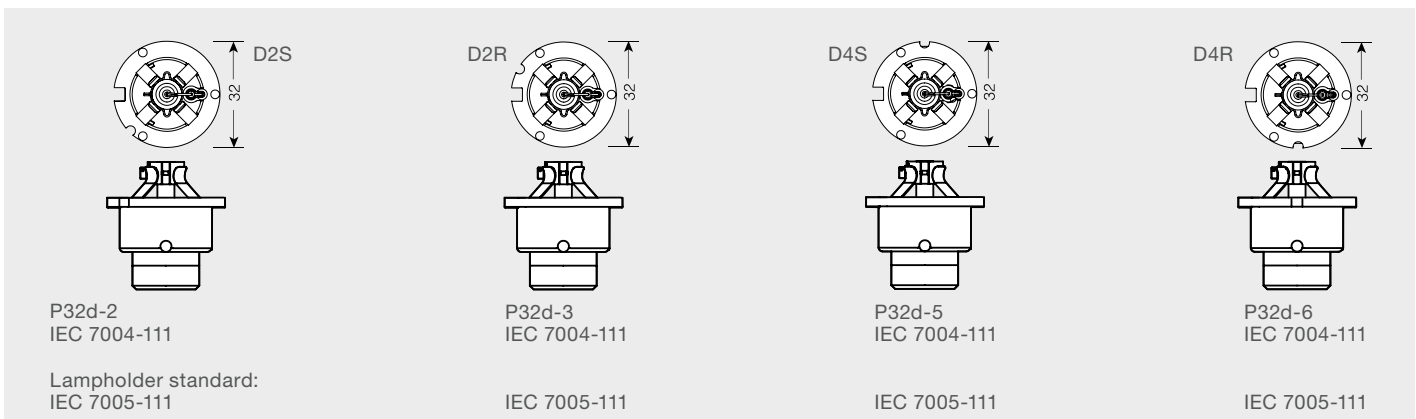
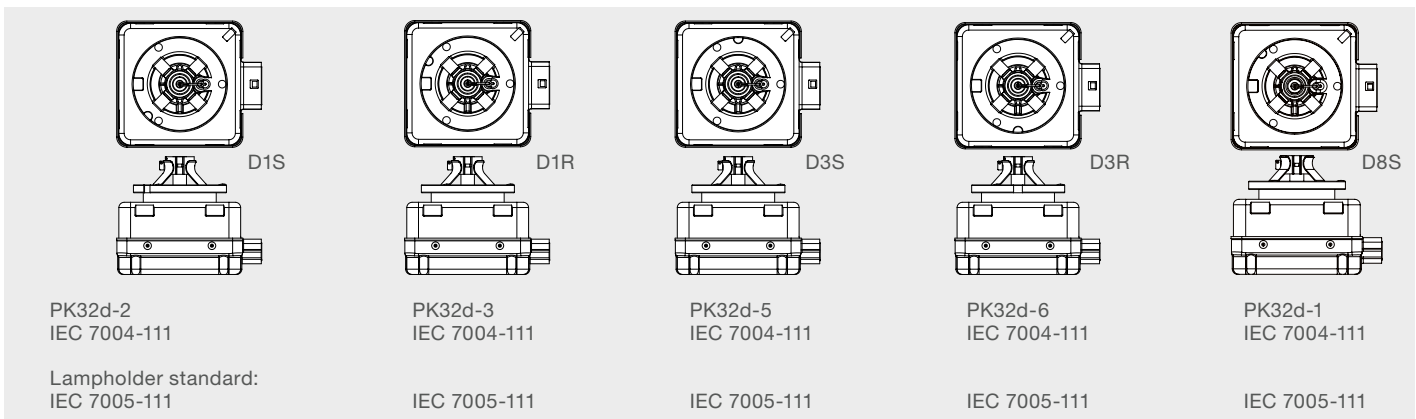
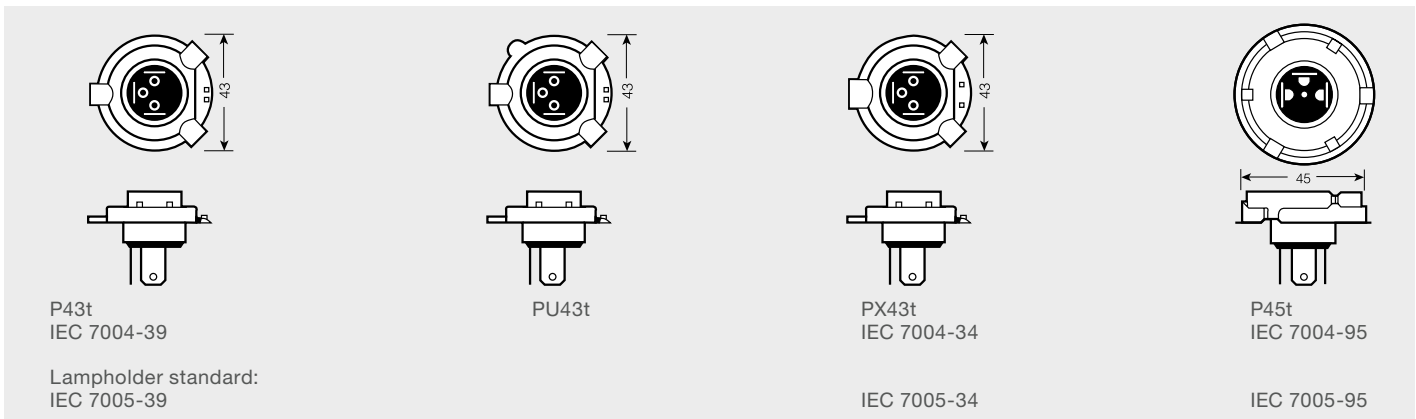
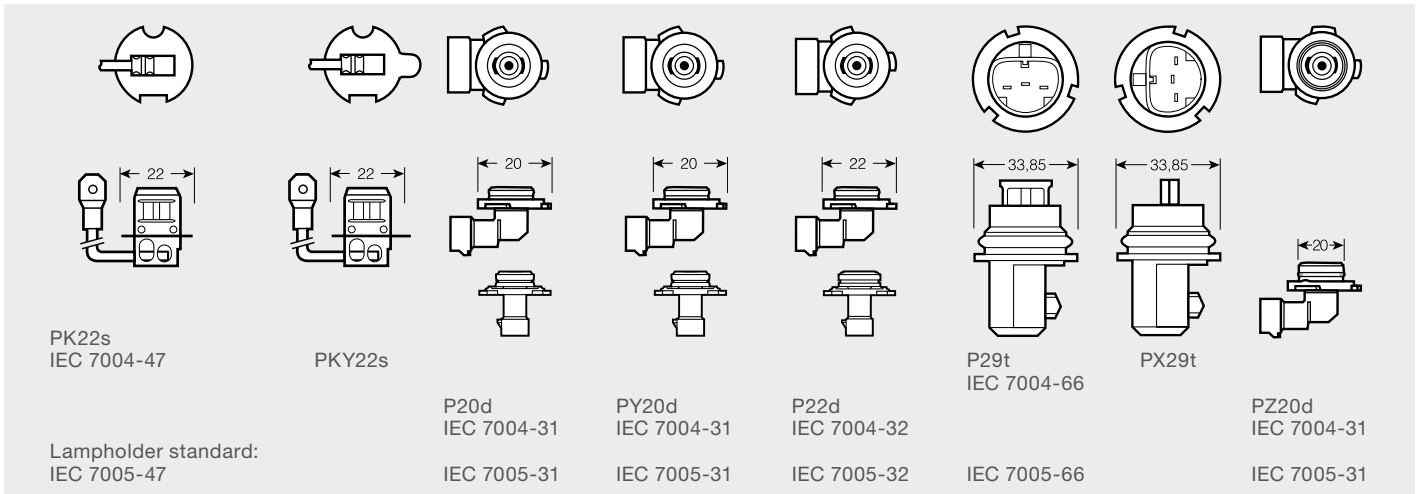

1=D1S, D3S, D8S | 2=D1R, D3R | 3=D2S, D4S | 4=D2R, D4R | 5=H1NBU | 6=H1 | 7=H1CBI | 8=H2 | 9=H3NBU | 10=H3 | 11=H3CBI | 12=H4CBI | 13=H4 Silver cap, H4 ULT, H4NR1 | 14=H4NBU, H4NR1, HS1NR9 | 15=H4XR, HS1XR | 16=H4SV2, HS1SVS | 17=H4, HS1, HB2 | 18=R2 | 19=H7NBU, H7NR1 | 20=H7CBI, H7XR | 21=H7SV2, H7 ULT, H7NR5 | 22=H7 | 23=HB4A | 24=H15 | 25=H16 26=H11B, H8B | 27=H11, H11SV2 | 28=H11CBI, H11XR | 29=H11NBU, H11NR1, H11NR5 | 30=H8 | 31=H8CBI, H8XR | 32=H9 | 33=H9B | 34=HB3 | 35=HB3CBI | 36=HB3NBU | 37=HB4NBU | 38=HB3A 39=HB4, H10 | 40=HB4CBI | 41=9007, HB5 | 42=H13 | 43=9004XV, HB1 | 44=H27W/1 | 45=H27W/2 | 46=HIR1 | 47=HIR2 | 48=S1, S2 | 49=P21W, 7529 | 50=P21W | 51=P21W old | 52=P21W 24V 53=P21/4W, P21/5W | 54=P21/5W old | 55=P21/5W | 56=PY21W, PR21W | 57=PY21W old | 58=PY21W | 59=PY21WTSP | 60=PR21/5W | 61=P27W | 62=P27/7W | 63=S8W | 64=S8W | 65=PY27/7W 66=R5W, R10W 12V | 67=RY10W | 68=R5W, R10W 24V | 69=W21/5W | 70=T20 DC | 71=T20 DC | 72=W21W | 73=T20 SC | 74=T20 SC | 75=WY21W | 76=T20 YE | 77=T20 YE | 78=W3W, 2820, 2840, W5W, 2886X | 79=W5W | 80=W5W | 81=W5WCB | 82=WY5W | 83=WY5W | 84=2721, 2722, 2723, 2741 | 85=W16W | 86=T16 | 87=W16W | 88=WY16W | 89=H21W | 90=HY21W | 91=C5W, 6461 | 92=C5W | 93=C5W | 94=6428, 6430 | 95=6438 | 96=6438 | 97=6438 | 98=6411, 6413, 6421, 6424, 6429 | 99=6411, 6413, 6421, 6424, 6429 | 100=6411, 6413, 6421, 6424, 6429 | 101=64115, 64111, 64113 | 102=H6W | 103=3796, 3860, 3893, 3930 | 104=T4W | 105=T4W | 106=2351MFX6, 2352MFX6, 2431MFX6, 2452MFX6, 2473MFX6, 2723MFX6 | 107=2721MF, 2721MFX, 2722MF, 2722MFX, 2741MF, 2741MFX, 2752MF, 2752MFX | 108=64122, 64124 | 109=H8, H11, H16 | 110=H10

						
SV7-8 IEC 7004-80	SV8.5-8 IEC 7004-81	W2x4.6d IEC 7004-94	W2.1x9.5d IEC 7004-91	W2.5x16d IEC 7004-104	W2.5x16q IEC 7004-104	
Lampholder standard: IEC 7005-80	IEC 7005-80	IEC 7005-94	IEC 7005-91	IEC 7005-104	IEC 7005-104	
						
BA9s IEC 7004-14	BAY9s IEC 7004-9	BAX9s IEC 7004-8	B8.4-12.5 BX8.4-12.5	B8.5d BX8.5d	BA15s IEC 7004-11A	BA15d IEC 7004-11A
Lampholder standard: IEC 7005-12	IEC 7005-9	IEC 7005-8	IEC 7004-140 IEC 7005-140		IEC 7005-13	
						
BAU15s IEC 7004-19	BAW15s IEC 7004-11 E	BAY15d IEC 7004-11 B	BAZ15d IEC 7004-11 C	BAW15d IEC 7004-11 E	BA20d IEC 7004-12	
Lampholder standard: IEC 7005-13	IEC 7005-13	IEC 7005-13	IEC 7005-13	IEC 7005-13	IEC 7005-14	
						
P14.5s IEC 7004-46	P26s IEC 7004-36	PX13.5s IEC 7004-35	PGJY19-2 PGJY19-5 PGJY19-1	PJ26.4t	PGJ23t-1	
Lampholder standard: IEC 7005-46	IEC 7005-36	IEC 7005-35	IEC 7004-146 IEC 7005-146	IEC 7004-128 IEC 7005-128	IEC 7004-155 IEC 7005-155	
						
PX14.5s	PX26d IEC 7004-5	IEC 7005-5	PGJ 19 PGJ 19-1 PGJ 19-2 PGJ 19-5 IEC 7004-110 IEC 7005-110			







Type overview by ECE/SAE category

ECE	V	W		Product Reference		ECE	V	W		Product Reference	
-	12	5	-	LEDCBCTRL101	P.35	-	12	2/0.4	BAY15d	1457YE ⁽¹⁾	P.33
-	12	21	-	LEDCBCTRL102	P.35	-	12	2/0.4	BAY15d	1557CW ⁽¹⁾	P.33
-	12	50	-	LEDCBCTRL103	P.35	-	12	2/0.4	BAY15d	1557R ⁽¹⁾	P.33
-	12	15	-	LEDDL102	P.23	-	12	2/0.4	BAY15d	1557YE ⁽¹⁾	P.33
-	12	13.5	-	LEDDL301 CL15	P.23	-	12	1.2	BX8.4d	2351MFX6	P.81
-	12	-	-	LEDEXT101	P.37	-	12	2	BX8.4d	2352MFX6	P.81
-	12	42	-	LEDEXT102-10	P.37	-	12	1.5	BX8.4d	2452MFX6	P.81
-	12	51	-	LEDEXT102-04	P.37	-	12	1.2	W2x4.6d	2721	P.80
-	12	60	-	LEDEXT102-03	P.37	-	12	1.2	B8.5d	2721MF	P.81
-	12/24	7/12	-	LEDFOG101	P.25	-	12	1.2	BX8.5d	2721MFX	P.81
-	-	-	-	LEDFOG101-VW-M	P.25	-	12	1.12	BX8.4d	2473MFX6	P.81
-	-	-	-	LEDFOG101-NIS-M	P.25	-	12	2	W2x4.6d	2722	P.80
-	-	-	-	LEDFOG101-INF-M	P.25	-	12	2	B8.5d	2722MF	P.81
-	-	-	-	LEDFOG101-TY-M	P.25	-	12	2	BX8.5d	2722MFX	P.81
-	12	4/12	-	LEDFOG103-SR	P.27	-	12	2	W2.1x9.5d	2820	P.80
-	12	4/12	-	LEDFOG103-GD	P.27	-	12	1	W2.1x9.5d	2850BL ⁽¹⁾	P.31
-	12	4/12	-	LEDFOG103-BL	P.27	-	12	1	W2.1x9.5d	2850CW ⁽¹⁾	P.31
-	12	8	-	LEDFOG201	P.27	-	12	1	W2.1x9.5d	2850WW ⁽¹⁾	P.31
-	-	-	-	FOG103/201-TY-M	P.27	-	12	1	W2.1x9.5d	2855YE ⁽¹⁾	P.31
-	-	-	-	FOG103/201-VW-M	P.27	-	12	0.5	W2.1x9.5d	2880BL ⁽¹⁾	P.31
-	-	-	-	FOG103/201-NIS-M	P.27	-	12	0.5	W2.1x9.5d	2880CW ⁽¹⁾	P.31
-	12	70	-	LEDHL102-BK	P.21	-	12	0.5	W2.1x9.5d	2880R ⁽¹⁾	P.31
-	12	70	-	LEDHL102-BK RHD	P.21	-	12	1	W2.1x9.5d	2880YE ⁽¹⁾	P.31
-	12	70	-	LEDHL102-CM	P.21	-	12	1	W2.1x9.5d	2880GR ⁽¹⁾	P.31
-	12	70	-	LEDHL102-GTI	P.21	-	12	6	W2.1x9.5d	2886X	P.80
-	3.4	3.5	-	LEDIL103	P.43	-	12	1	W2.5x9.5d	3547YE ⁽¹⁾	P.33
-	220	13-15	-	LEDIL104	P.43	-	12	2.5	W2.5x9.5d	3547CW ⁽¹⁾	P.33
-	3.7	0.5	-	LEDIL105	P.43	-	12	3	W2.5x9.5d	3547R ⁽¹⁾	P.33
-	3.7	0.5	-	LEDIL106	P.43	-	12	1.42/0.54	W2.5x16q	3557CW ⁽¹⁾	P.33
-	3.7	1	-	LEDIL107	P.43	-	12	1.42/0.54	W2.5x16q	3557R ⁽¹⁾	P.33
-	4.5	1.5	-	LEDIL201	P.47	-	12	1.42/0.54	W2.5x16q	3557YE ⁽¹⁾	P.33
-	4.5	1.6	-	LEDIL202	P.47	-	12	2	BA9s	3796	P.80
-	4.5	1.5	-	LEDIL203	P.47	-	12	1	BA9s	3850CW ⁽¹⁾	P.31
-	4.5	1.5	-	LEDIL204	P.47	-	12	1	BA9s	3850WW ⁽¹⁾	P.31
-	4.5	1.5	-	LEDIL205	P.47	-	12	5	BA9s	3860	P.80
-	4.5	1.5	-	LEDIL206	P.47	-	12	10	SV8.5-8	6411	P.81
-	4.5	1.5	-	LEDIL207	P.47	-	12	5	SV8.5-8	6413	P.81
-	4.5	1.5	-	LEDIL209	P.47	-	12	3	SV7-8	6428	P.81
-	12	-	-	LEDINT102	P.37	-	12	10	SV8.5-8	6438	P.81
-	12	-	-	LEDINT103	P.37	-	12	10	SV8.5-8	6461	P.80
-	12	-	-	LEDINT104	P.37	-	12	0.5	SV8.5-8	6431CW ⁽¹⁾	P.31
-	12	-	-	LEDINT201	P.39	-	12	0.5	SV8.5-8	6431BL ⁽¹⁾	P.31
-	12	-	-	LEDINT202	P.39	-	12	0.5	SV8.5-8	6436CW ⁽¹⁾	P.31
-	12	-	-	LEDINT201-SEC	P.39	-	12	0.5	SV8.5-8	6436BL ⁽¹⁾	P.31
-	12	-	-	LEDINT203	P.39	-	12	0.5	SV8.5-8	6441CW ⁽¹⁾	P.31
-	3	1.7	-	LEDSL101	P.49	-	12	0.5	SV8.5-8	6441BL ⁽¹⁾	P.31
-	4.5	0.5	-	LEDSL302	P.49	-	12	1	SV8.5-8	6497CW ⁽¹⁾	P.31
-	12/24	0.5	-	ONYX L-7	P.51	-	12	1	SV8.5-8	6497WW ⁽¹⁾	P.31
-	12/24	0.5	-	ONYX M-7	P.51	-	12	1	SV8.5-8	6498CW ⁽¹⁾	P.31
-	12	27	PG13	880CBI	P.73	-	12	1	SV8.5-8	6498WW ⁽¹⁾	P.31
-	12	27	PGJ13	881CBI	P.73	-	12	1	SV8.5-8	6499CW ⁽¹⁾	P.31
-	12	2/0.4	BAY15d	1457CW ⁽¹⁾	P.33	-	12	1	SV8.5-8	6499WW ⁽¹⁾	P.31
-	12	2/0.4	BAY15d	1457R ⁽¹⁾	P.33	-	12	21/5	BA15d	7240	P.80

ECE	V	W		Product Reference	
-	12	2	BA15s	7456CW ¹⁾	P.33
-	12	2	BA15s	7456R ¹⁾	P.33
-	12	2	BA15s	7456YE ¹⁾	P.33
-	12	2	BAU15s	7457YE ¹⁾	P.33
-	12	2	BA15s	7556CW ¹⁾	P.33
-	12	2	BA15s	7556R ¹⁾	P.33
-	12	2	BA15s	7556YE ¹⁾	P.33
-	12	2	BAU15s	7557YE ¹⁾	P.33
-	12	1	W3x16d	7705YE ¹⁾	P.33
-	12	2.5	W3x16d	7705CW ¹⁾	P.33
-	12	3	W3x16d	7705R ¹⁾	P.33
-	12	1	W3x16q	7715YE ¹⁾	P.33
-	12	2.5	W3x16q	7715CW ¹⁾	P.33
-	12	3	W3x16q	7715R ¹⁾	P.33
-	12	1.5	W3x16d	7905R ¹⁾	P.33
-	12	1.5	W3x16d	7905YE ¹⁾	P.33
-	12	3	W3x16d	7905CW ¹⁾	P.33
-	12	1.5	W3x16q	7915R ¹⁾	P.33
-	12	1.5	W3x16q	7915YE ¹⁾	P.33
-	12	3	W3x16q	7915CW ¹⁾	P.33
-	12	1.8	W2.1x9.5d	9212CW ¹⁾	P.33
-	12	2	W2.1x9.5d	9213R ¹⁾	P.33
-	12	3	W2.1x9.5d	9213CW ¹⁾	P.33
-	12	13	PY20d	9645CW	P.29
-	12	80	P14.5s	62150CBB ²⁾	P.101
-	12	20	BA9s	64111	P.81
-	12	5	BA9s	64115	P.81
-	12	100/90	P43t	62193CBB ²⁾	P.101
-	12	100	P14.5s	62200SBP ²⁾	P.99
-	12	100	PK22s	62201SBP ²⁾	P.99
-	12	100/90	P43t	62204SBP ²⁾	P.99
-	12	80	PX26d	62210CBB ²⁾	P.101
-	12	75	PGJ19-2	62211CBB ²⁾	P.101
-	12	75	PGJ19-5	62213CBB ²⁾	P.101
-	12	80	PX26d	62261SBP ²⁾	P.99
-	12	100	PX14.5s	64152SB ²⁾	P.99
-	12	100	PKX22s	64153SB ²⁾	P.99
-	12	100/90	PU43t	64194SB ²⁾	P.99
-	12	60/55	P45t	64198SB ²⁾	P.99
-	12	100/90	P45t	64204SB ²⁾	P.99
-	12	13	PGJ19	66220CW	P.29
-	12/24	35	PK32d-2	66140CBB ²⁾	P.101
-	12/24	35	P32d-2	66240CBB ²⁾	P.101
-	12/24	35	PK32d-5	66340CBB ²⁾	P.101
-	12/24	35	P32d-5	66440CBB ²⁾	P.101
-	12	100	P20d	69005SBP ²⁾	P.99
-	12	100	P20d	69005CBB ²⁾	P.101
-	12	80	P22d	69006SBP ²⁾	P.99
-	12	80	P22d	69006CBB ²⁾	P.101
-	24	1	W2x4.6d	2341	P.95
-	24	1	W2.1x9.5d	2824CW ¹⁾	P.31
-	24	1	W2.1x9.5d	2824WW ¹⁾	P.31
-	24	1	BA9s	3924CW ¹⁾	P.33
-	24	1	BA9s	3924WW ¹⁾	P.33
-	24	1.2	W2x4.6d	2741	P.95
-	24	1.2	B8.5d	2741MF	P.95
-	24	1.2	BX8.5d	2741MFX	P.95
-	24	2	W2.1x9.5d	2840	P.95
-	24	3	SV8.5-8	6421	P.95
-	24	3	SV8.5-8	6430	P.95
-	24	5	SV8.5-8	6424	P.95
-	24	10	SV8.5-8	6429	P.95
-	24	15	BA15s	7529	P.95
C5W	12	5	SV8.5-8	6418	P.81
C5W	24	5	SV8.5-8	6423	P.95
C5W	12	5	SV8.5-8	6418ULT	P.77
D1S	85	35	PK32d-2	66140	P.63
D1S	85	35	PK32d-2	66140XNB	P.57
D1S	85	35	PK32d-2	66140CBI	P.59
D1S	85	35	PK32d-2	66140ULT	P.61
D1R	85	35	PK32d-3	66150	P.63
D1R	85	35	PK32d-3	66150CBI	P.59
D2S	85	35	P32d-2	66240	P.63
D2S	85	35	P32d-2	66240XNB	P.57
D2S	85	35	P32d-2	66240CBI	P.59
D2S	85	35	P32d-2	66240ULT	P.61
D2R	85	35	P32d-3	66250	P.63
D2R	85	35	P32d-3	66250CBI	P.59
D3S	42	35	PK32d-5	66340	P.63
D3S	42	35	PK32d-5	66340XNB	P.57
D3S	42	35	PK32d-5	66340CBI	P.59
D3S	42	35	PK32d-5	66340ULT	P.61
D3R	42	35	PK32d-6	66350	P.63
D4S	42	35	P32d-5	66440	P.63
D4S	42	35	P32d-5	66440XNB	P.57
D4S	42	35	P32d-5	66440CBI	P.59
D4S	42	35	P32d-5	66440ULT	P.61
D4R	42	35	P32d-6	66450	P.63
D8S	42	25	PK32d-1	66548	P.63
H1	12	55	P14.5s	64150	P.79
H1	12	55	P14.5s	64150NBL	P.67
H1	12	55	P14.5s	64150NBU	P.69
H1	12	55	P14.5s	64150SV2	P.71
H1	12	55	P14.5s	64150CBI	P.73
H1	12	55	P14.5s	64150ULT	P.77
H1	24	70	P14.5s	64155	P.95
H1	24	70	P14.5s	64155TSP	P.93
H10	12	42	PY20d	9145	P.79
H11	12	55	PGJ19-2	64211	P.79
H11	12	55	PGJ19-2	64211NBU	P.69
H11	12	55	PGJ19-2	64211SV2	P.71
H11	12	55	PGJ19-2	64211CBI	P.73
H11	12	55	PGJ19-2	64211ULT	P.77
H11	12	55	PGJ19-2	64211NR1	P.85
H11	12	55	PGJ19-2	64211NR5	P.87
H11	12	55	PGJ19-2	64211XR	P.89

ECE	V	W		Product Reference	
H11	24	70	PGJ19-2	64216TSP	P.93
H11B	12	55	PGJY19-2	64241	P.79
H13	12	60/55	P26.4t	9008	P.79
H15	12	55/15	PGJ23t-1	64176	P.79
H15	12	55/15	PGJ23t-1	64176CBI	P.73
H15	24	20/60	PGJ23t-1	64177	P.95
H16	12	19	PGJ19-3	64219L+	P.79
H16	12	19	PGJ19-3	64219CBI	P.73
H2	12	55	X511	64173	P.79
H2	24	70	X511	64175	P.95
H21W	12	21	BAY9s	64136	P.81
H21W	24	21	BAY9s	64138	P.95
H27W/1	12	27	PGJ13	880	P.79
H27W/2	12	27	PGJ13	881	P.79
H3	12	55	PK22s	64151	P.79
H3	12	55	PK22s	64151NBU	P.69
H3	12	55	PK22s	64151CBI	P.73
H3	24	70	PK22s	64156	P.95
H3	24	70	PK22s	64156TSP	P.93
H4	12	60/55	P43t	64193	P.79
H4	12	60/55	P43t	64193NBL	P.67
H4	12	60/55	P43t	64193NBU	P.69
H4	12	60/55	P43t	64193SV2	P.71
H4	12	60/55	P43t	64193CBI	P.73
H4	12	60/55	P43t	64193ULT	P.77
H4	12	60/55	P43t	64193NR1	P.85
H4	12	60/55	P43t	64193NR5	P.87
H4	12	60/55	P43t	64193XR	P.89
H4	24	75/70	P43t	64196	P.95
H4	24	75/70	P43t	64196TSP	P.93
H4	24	75/70	P43t	94196	P.95
H6W	12	6	BAX9s	64132	P.81
H6W	12	6	BAX9s	64132ULT	P.77
H7	12	55	PX26d	64210	P.79
H7	12	55	PX26d	64210NBL	P.67
H7	12	55	PX26d	64210NBU	P.69
H7	12	55	PX26d	64210SV2	P.71
H7	12	55	PX26d	64210CBI	P.73
H7	12	55	PX26d	64210ULT	P.77
H7	12	55	PX26d	64210NR1	P.85
H7	12	55	PX26d	64210NR5	P.87
H7	12	55	PX26d	64210XR	P.89
H7	24	70	PX26d	64215	P.95
H7	24	70	PX26d	64215TSP	P.93
H8	12	35	PGJ19-1	64212	P.79
H8	12	35	PGJ19-1	64212NBU	P.69
H8	12	35	PGJ19-1	64212CBI	P.73
H8	12	35	PGJ19-1	64212XR	P.89
H8B	12	35	PGJY19-1	64242	P.79
H9	12	65	PGJ19-5	64213	P.79
H9B	12	65	PGJY19-5	64243	P.79
HB3	12	60	P20d	9005	P.79
HB3	12	60	P20d	9005NBU	P.69
HB3	12	60	P20d	9005CBI	P.73
HB3A	12	60	P20d	9005XS	P.79
HB4	12	51	P22d	9006	P.79
HB4	12	51	P22d	9006NBU	P.69
HB4	12	51	P22d	9006CBI	P.73
HB4A	12	51	P20d	9006XS	P.79
HB5	12	65/55	PX29t	9007	P.79
HIR1	12	65	PX20d	9011	P.79
HIR2	12	55	PX22d	9012	P.79
HS1	12	35/35	PX43t	64185	P.79
HS1	12	35/35	PX43t	64185NR5	P.87
HS1	12	35/35	PX43t	64185NR9	P.85
HS1	12	35/35	PX43t	64185XR	P.89
HY21W	12	21	BAW9s	64137ULT	P.77
P21W	12	21	BA15s	7506	P.80
P21W	12	21	BA15s	7506ULT	P.77
P21W	24	21	BA15s	7511	P.95
P21W	24	21	BA15s	7511TSP	P.93
P21/4W	12	21/4	BAZ15d	7225	P.80
P21/5W	12	21/5	BAY15d	7528	P.80
P21/5W	12	21/5	BAY15d	7528ULT	P.77
P21/5W	24	21/5	BAY15d	7537	P.95
P21/5W	24	21/5	BAY15d	7537TSP	P.93
P27W	12	27	W2.5x16d	3156	P.81
P27/7W	12	27/7	W2.5x16q	3157	P.81
PR21W	12	21	BAW15s	7508LDR	P.75
PR21/5W	12	21/5	BAW15d	7538LDR	P.75
PY21W	12	21	BAU15s	7507	P.80
PY21W	12	21	BAU15s	7507ULT	P.77
PY21W	12	21	BAU15s	7507DC	P.75
PY21W	12	21	BAU15s	7507LDA	P.75
PY21W	24	21	BAU15s	7510TSP	P.93
PY27/7W	12	27/7	W2.5x16q	3757AK	P.81
R10W	12	10	BA15s	5008	P.80
R10W	12	10	BA15s	5008ULT	P.77
R10W	24	10	BA15s	5637	P.95
R10W	24	10	BA15s	5637TSP	P.93
R2	12	45/40	P45t	64183	P.79
R5W	12	5	BA15s	5007	P.80
R5W	12	5	BA15s	5007ULT	P.77
R5W	24	5	BA15d	5626	P.95
R5W	24	5	BA15s	5627	P.95
R5W	24	5	BA15s	5627TSP	P.93
RY10W	12	10	BAU15s	5009	P.80
S1	12	25/25	BA20d	64326	P.89
S2	12	35/35	BA20d	64327	P.89
S2	12	35/35	BA20d	64327XR	P.89
T4W	12	4	BA9s	3893	P.80
T4W	24	4	BA9s	3930	P.95
T4W	24	4	BA9s	3930TSP	P.93
W16W	12	16	W2.1x9.5d	921	P.80
W2.3W	12	2.3	W2x4.6d	2723	P.80
W21/5W	12	21/5	W3x16q	7515	P.80

				Product Reference	
W21W	12	21	W3x16d	7505	P.80
W3W	12	3	W2.1x9.5d	2821	P.80
W3W	24	3	W2.1x9.5d	2841	P.95
W5W	12	5	W2.1x9.5d	2825	P.80
W5W	12	5	W2.1x9.5d	2825ULT	P.77
W5W	12	5	W2.1x9.5d	2825HCBI	P.73
W5W	24	5	W2.1x9.5d	2845	P.95
W5W	24	5	W2.1x9.5d	2845TSP	P.93
WY5W	12	5	W2.1x9.5d	2827	P.80
WY5W	12	5	W2.1x9.5d	2827DC	P.75
WY16W	12	16	W2.1x9.5d	921NA	P.80
WY21W	12	21	WX3x16d	7504	P.80

1) OFF-ROAD only when used in an exterior application. These products do not have ECE approval. This means that they cannot be fitted in exterior lights if the vehicle is to be used on public roads.

2) These products do not have ECE approval. This means that they cannot be fitted in "normal" headlights or additional headlights if the vehicle is to be used on public roads.

Type overview in numerical order of product reference with test data

Product Reference	ECE	V	W		V _{Test}	W _{in}	Im	T[h] B3/Tc 1)	
880	H27W/1	12	27	PG13	13.5	31	450	-	P.79
880CBI	H27W/1	12	27	PG13	13.5	max. 31	477	-	P.73
881	H27W/2	12	27	PGJ13	13.5	31	450	-	P.79
881CBI	H27W/2	12	27	PGJ13	13.5	max. 31	477	-	P.73
921	W16W	12	16	W2.1x9.5d	13.5	19.4	310	400/1000	P.80
921NA	WY16W	12	16	W2.1x9.5d	13.5	19.4	190	400/1000	P.80
1457CW	-	12	2/0.4	BAY15d	13.5	-	150/45	avg: 2000	P.33
1457R	-	12	2/0.4	BAY15d	13.5	-	90/14	avg: 2000	P.33
1457YE	-	12	2/0.4	BAY15d	13.5	-	16/6	avg: 2000	P.33
1557CW	-	12	2/0.4	BAY15d	13.5	-	200/26	2500/5000	P.33
1557R	-	12	2/0.4	BAY15d	13.5	-	118/8	2500/5000	P.33
1557YE	-	12	2/0.4	BAY15d	13.5	-	68/6	2500/5000	P.33
2341	-	24	1	W2x4.6d	28.0	1	3	300/1000	P.95
2351MFX6	-	12	1.2	BX8.4d	13.5	1.32	7.5	600/3000	P.81
2352MFX6	-	12	2	BX8.4d	13.5	2.13	11.8	1500/6000	P.81
2452MFX6	-	12	1.5	BX8.4d	13.5	1.8	6.5	1700/6500	P.81
2473MFX6	-	12	1.12	BX8.4d	14.0	1.12	3.6	500/5000	P.81
2721	-	12	1.2	W2x4.6d	13.5	1.22	7.5	500/2000	P.80
2721MF	-	12	1.2	B8.5d	13.5	1.2	6.4	500/2000	P.81
2721MFX	-	12	1.2	BX8.5d	13.5	1.2	6.4	500/2000	P.81
2722	-	12	2	W2x4.6d	13.5	2	12	1300/4000	P.80
2722MF	-	12	2	B8.5d	13.5	2	10.2	1300/4000	P.81
2722MFX	-	12	2	BX8.5d	13.5	2	10.2	1300/4000	P.81
2723	W2.3W	12	2.3	W2x4.6d	13.5	2.5	18.6	350/1200	P.81
2741	-	24	1.2	W2x4.6d	28.0	1.6	7.5	400/2000	P.95
2741MF	-	24	1.2	B8.5d	28.0	1.6	6.4	400/2000	P.95
2741MFX	-	24	1.2	BX8.5d	28.0	1.6	6.4	400/2000	P.95
2820	-	12	2	W2.1x9.5d	13.5	2.2	13.5	600/4000	P.80
2821	W3W	12	3	W2.1x9.5d	13.5	3	22	1300/4000	P.80
2824CW ²⁾	-	24	1	W2.1x9.5d	28	1	55	2500/5000	P.31
2824WW ²⁾	-	24	1	W2.1x9.5d	28	1	55	2500/5000	P.31
2825	W5W	12	5	W2.1x9.5d	13.5	5	50	350/1000	P.80
2825HCBI	W5W	12	5	W2.1x9.5d	13.5	5	50	350/1000	P.73
2825ULT	W5W	12	5	W2.1x9.5d	13.5	5	50	700/1500	P.77
2827	WY5W	12	5	W2.1x9.5d	13.5	5	30	350/1000	P.80
2827DC	WY5W	12	5	W2.1x9.5d	13.5	5	30	200/500	P.75
2840	-	24	2	W2.1x9.5d	28.0	2.6	13	500/5000	P.95
2841	W3W	24	3	W2.1x9.5d	28.0	4	22	500/5000	P.95
2845	W5W	24	5	W2.1x9.5d	28.0	7	50	800/3000	P.95
2845TSP	W5W	24	5	W2.1x9.5d	28.0	7	50	1000/4000	P.93
2850BL ²⁾	-	12	1	W2.1x9.5d	13.5	-	16	5000	P.31
2850CW ²⁾	-	12	1	W2.1x9.5d	13.5	-	70	2500/5000	P.31
2850WW ²⁾	-	12	1	W2.1x9.5d	13.5	-	55	2500/5000	P.31
2855YE ²⁾	-	12	1	W2.1x9.5d	13.5	-	30	2500/5000	P.31
2880BL ²⁾	-	12	0.5	W2.1x9.5d	13.5	-	9	avg: 2000	P.31
2880CW ²⁾	-	12	0.5	W2.1x9.5d	13.5	-	45	avg: 2000	P.31
2880YE ²⁾	-	12	1	W2.1x9.5d	13.5	-	7	avg: 2000	P.31
2880GR ²⁾	-	12	0.5	W2.1x9.5d	13.5	-	17	avg: 2000	P.31
2880R ²⁾	-	12	0.5	W2.1x9.5d	13.5	-	17	avg: 2000	P.31
2886X	-	12	6	W2.1x9.5d	13.5	6	85	400/1000	P.80

Product Reference	ECE	V	W		V _{Test}	W _{in}	lm	T _{B3/Tc} [h] ¹⁾	
3156	P27W	12	27	W2.5x16d	13.5	29.2	475	600/0	P.81
3157	P27/7W	12	27/7	W2.5x16q	13.5	29.2/7.7	475/36	600/5000	P.81
3547CW	-	12	2.5	W2.5x16q	13.5	-	150/45	avg: 2000	P.33
3547R	-	12	3	W2.5x16q	13.5	-	90/14	avg: 2000	P.33
3547YE	-	12	1	W2.5x16q	13.5	-	16/6	avg: 2000	P.33
3557CW	-	12	1.42/0.54	W2.5x16q	13.5	-	200/26	2500/5000	P.33
3557R	-	12	1.42/0.54	W2.5x16q	13.5	-	118/8	2500/5000	P.33
3557YE	-	12	1.42/0.54	W2.5x16q	13.5	-	68/6	2500/5000	P.33
3757AK	-	12	27/7	W2.5x16q	13.5	29.2/17.7	280/21	460/1100	P.81
3796	-	12	2	BA9s	13.5	2	12.5	300/750	P.81
3850CW ²⁾	-	12	1	BA9s	13.2	-	50	500/1000	P.31
3850WW ²⁾	-	12	1	BA9s	13.2	-	50	500/1000	P.31
3860	-	12	5	BA9s	13.5	5	50	400/1000	P.80
3893	T4W	12	4	BA9s	13.5	4	35	600/1200	P.80
3924CW ²⁾	-	24	1	BA9s	28	-	55	2500/5000	P.33
3924WW ²⁾	-	24	1	BA9s	28	-	55	2500/5000	P.33
3930	T4W	24	4	BA9s	28.0	5	35	250/500	P.95
3930TSP	T4W	24	4	BA9s	28.0	5	35	550/1000	P.93
5007	R5W	12	5	BA15s	13.5	5	50	350/800	P.81
5007ULT	R5W	12	5	BA15s	13.5	5	50	600/1200	P.77
5008	R10W	12	10	BA15s	13.5	10	125	350/800	P.81
5008ULT	R10W	12	10	BA15s	13.5	10	125	600/1200	P.77
5009	RY10W	12	10	BAU15s	13.5	10	75	350/800	P.81
5626	R5W	24	5	BA15d	28.0	7	50	80/250	P.95
5627	R5W	24	5	BA15s	28.0	7	50	500/1000	P.95
5627TSP	R5W	24	5	BA15s	28.0	7	50	800/2000	P.93
5637	R10W	24	10	BA15s	28.0	12.5	125	400/800	P.95
5637TSP	R10W	24	10	BA15s	28.0	12.5	125	1000/2000	P.93
6411	-	12	10	SV8.5-8	13.5	10	100	500/1000	P.81
6413	-	12	5	SV8.5-8	13.5	5	45	1000/2000	P.81
6418	C5W	12	5	SV8.5-8	13.5	5	45	1000/2000	P.81
6418ULT	C5W	12	5	SV8.5-8	13.5	5	45	1500/4000	P.77
6421	-	24	3	SV8.5-8	24.0	3	17	800/1500	P.95
6423	C5W	24	5	SV8.5-8	28.0	7	45	1500/4000	P.95
6424	-	24	5	SV8.5-8	28.0	7	60	1000/2000	P.95
6428	-	12	3	SV7-8	13.5	3.5	29	600/1200	P.81
6429	-	24	10	SV8.5-8	28.0	10	105	300/600	P.95
6430	-	24	3	SV7-8	28.0	3	23	400/800	P.95
6431CW ²⁾	-	12	0.5	SV8.5-8	13.5	-	30	avg: 2000	P.31
6431BL ²⁾	-	12	0.5	SV8.5-8	13.5	-	4	avg: 2000	P.31
6436CW ²⁾	-	12	0.5	SV8.5-8	13.5	-	30	avg: 2000	P.31
6436BL ²⁾	-	12	0.5	SV8.5-8	13.5	-	4	avg: 2000	P.31
6438	-	12	10	SV8.5-8	13.0	10	120	200/500	P.81
6441CW ²⁾	-	12	0.5	SV8.5-8	13.5	-	30	avg: 2000	P.31
6441BL ²⁾	-	12	0.5	SV8.5-8	13.5	-	4	avg: 2000	P.31
6461	-	12	10	SV8.5-8	13.5	10	105	600/1200	P.81
6497CW ²⁾	-	12	1	SV8.5-8	13.5	max. 1.3	35	2500/5000	P.31
6497WW ²⁾	-	12	1	SV8.5-8	13.5	max. 1.3	35	2500/5000	P.31
6498CW ²⁾	-	12	1	SV8.5-8	13.5	max. 1.3	30	2500/5000	P.31
6498WW ²⁾	-	12	1	SV8.5-8	13.5	max. 1.3	30	2500/5000	P.31

Product Reference	ECE	V	W		V _{Test}	W _h	lm	T[h] _{B3/7c} 1)	
6499CW ²⁾	-	12	1	SV8.5-8	13.5	max. 1.3	35	2500/5000	P.31
6499WW ²⁾	-	12	1	SV8.5-8	13.5	max. 1.3	35	2500/5000	P.31
7225	P21/4W	12	21/4	BAZ15d	13.5	25/5	440/15	180/1250 //290/4000	P.80
7240	-	12	21/5	BA15d	13.5	25/6	440/35	180/1250//290/4000	P.80
7456CW	-	12	2	BA15s	13.5	-	190	avg: 2000	P.33
7456R	-	12	2	BA15s	13.5	-	107	avg: 2000	P.33
7456YE	-	12	2	BA15s	13.5	-	22	avg: 2000	P.33
7457YE	-	12	2	BAU15s	13.5	-	22	avg: 2000	P.33
7504	WY21W	12	21	WX3x16d	13.5	25	280	400/600	P.80
7505	W21W	12	21	W3x16d	13.5	25	460	400/600	P.80
7506	P21W	12	21	BA15s	13.5	25	460	250/500	P.80
7506ULT	P21W	12	21	BA15s	13.5	25	460	500/1000	P.77
7507	PY21W	12	21	BAU15s	13.5	25	280	250/500	P.80
7507ULT	PY21W	12	21	BAU15s	13.5	25	280	500/1000	P.77
7507DC	PY21W	12	21	BAU15s	13.5	25	280	100/250	P.75
7507LDA	PY21W	12	21	BAU15s	13.5	25	280	500/1000	P.75
7508LDR	PR21W	12	21	BAW15s	13.5	25	110	500/1000	P.75
7510TSP	PY21W	24	21	BAU15s	28.0	28	250	250/500	P.93
7511	P21W	24	21	BA15s	28.0	28	460	200/400	P.95
7511TSP	P21W	24	21	BA15s	28.0	28	460	250/500	P.93
7515	W21/5W	12	21/5	W3x16q	13.5	25/6	440/35	400/600//3000/3000	P.80
7528	P21/5W	12	21/5	BAY15d	13.5	25/6	440/35	180/1250//290/4000	P.80
7528ULT	P21/5W	12	21/5	BAY15d	13.5	25/6	440/35	300/3000//800/6000	P.77
7529	-	24	15	BA15s	28.0	15	210	100/300	P.95
7537	P21/5W	24	21/5	BAY15d	28.0	28/10	440/40	60/600//160/1600	P.95
7537TSP	P21/5W	24	21/5	BAY15d	28.0	28/10	440/40	100/1000//200/2000	P.93
7538LDR	PR21/5W	12	21/5	BAW15d	13.5	25/6	105/8	300/3000//800/6000	P.75
7556CW	-	12	2	BA15s	13.5	-	200	2500/5000	P.33
7556R	-	12	2	BA15s	13.5	-	115	2500/5000	P.33
7556YE	-	12	2	BA15s	13.5	-	68	2500/5000	P.33
7557YE	-	12	2	BAU15s	13.5	-	68	2500/5000	P.33
7705CW	-	12	2.5	W3x16d	13.5	-	190	avg: 2000	P.33
7705R	-	12	3	W3x16d	13.5	-	107	avg: 2000	P.33
7705YE	-	12	1	W3x16d	13.5	-	22	avg: 2000	P.33
7715CW	-	12	3	W3x16q	13.5	-	150/45	avg: 2000	P.33
7715R	-	12	1.5	W3x16q	13.5	-	90/14	avg: 2000	P.33
7715YE	-	12	1.5	W3x16q	13.5	-	16/6	avg: 2000	P.33
7905CW	-	12	3	W3x16d	13.5	-	230	2500/5000	P.33
7905R	-	12	1.5	W3x16d	13.5	-	50	2500/5000	P.33
7905YE	-	12	1.5	W3x16d	13.5	-	40	2500/5000	P.33
7915CW	-	12	3	W3x16q	13.5	-	170/50	2500/5000	P.33
7915R	-	12	1.5	W3x16q	13.5	-	40/12	2500/5000	P.33
7915YE	-	12	1.5	W3x16q	13.5	-	35/7	2500/5000	P.33
9005	HB3	12	60	P20d	13.2	73	1860	280/550	P.79
9005NBU	HB3	12	60	P20d	13.2	73	1860	110/210	P.69
9005CBI	HB3	12	60	P20d	13.2	73	1860	110/220	P.73
9005XS	HB3A	12	60	P20d	13.2	max. 73	1860	-	P.79
9006	HB4	12	51	P22d	13.2	62	1095	860/1720	P.79
9006NBU	HB4	12	51	P22d	13.2	62	1095	270/500	P.69
9006CBI	HB4	12	51	P22d	13.2	62	1095	260/520	P.73

Product Reference	ECE	V	W		V _{Test}	W _h	lm	T[h] _{B3/Tc} 1)	
9006XS	HB4A	12	51	P20d	13.2	62	1095	860/1720	P.79
9007	HB5	12	65/55	PX29t	12.8	70/60	1350/1000	250/500	P.79
9008	H13	12	60/55	P26.4t	13.2	75/68	1700/1100	170/1290//350/2590	P.79
9011	HIR1	12	65	PX20d	13.2	max. 73	2500	220/300	P.79
9012	HIR2	12	55	PX22d	13.2	max. 63	1875	500/870	P.79
9012CBI	HIR2	12	55	PX22d	13.2	63	1875	300/500	P.73
9145	H10	12	42	PY20d	13.2	50	850	860/1720	P.79
9212CW	-	12	1.8	W2.1x9.5d	12	13	730	-	P.33
9213CW	-	12	3	W2.1x9.5d	13.5	-	230	2500/5000	P.33
9213R	-	12	2	W2.1x9.5d	13.5	-	95	2500/5000	P.33
9645CW	-	12	13	PY20d	-	-	730	-	P.29
62150CBB ³⁾	-	12	80	P14.5s	13.2	80	1150	75/150	P.81
62193CBB ³⁾	-	12	100/90	P43t	13.2	100/90	1600/760	60/200//120/400	P.81
62200SBP ³⁾	-	12	100	P14.5s	13.2	max. 94	2600	23/50	P.99
62201SBP ³⁾	-	12	100	PK22s	13.2	max. 95	2300	22/50	P.99
62204SBP ³⁾	-	12	100/90	P43t	13.2	100/90	2900/1530	100/200//300/550	P.99
62210CBB ³⁾	-	12	80	PX26d	13.2	80	1100	150/350	P.101
62211CBB ³⁾	-	12	75	PGJ19-2	13.2	75	1000	200/400	P.101
62213CBB ³⁾	-	12	75	PGJ19-5	13.2	75	1100	200/400	P.101
62261SBP ³⁾	-	12	80	PX26d	13.2	80	1950	250/500	P.99
64111	-	12	5	BA9s	13.5	5	80	150/500	P.81
64113	-	12	10	BA9s	13.5	10	200	150/400	P.81
64115	-	12	20	BA9s	13.5	22.5	450	150/500	P.81
64132	H6W	12	6	BAX9s	13.5	7	125	350/700	P.80
64132ULT	H6W	12	6	BAX9s	13.5	7	125	600/1000	P.77
64136	H21W	12	21	BAY9s	13.5	25	600	300/600	P.80
64137ULT	HY21W	12	21	BAW9s	13.5	26.25	300	400/700	P.77
64138	H21W	24	21	BAY9s	28.0	28	600	150/400	P.95
64150	H1	12	55	P14.5s	13.2	68	1550	400/650	P.79
64150NBU	H1	12	55	P14.5s	13.2	68	1550	150/300	P.69
64150SV2	H1	12	55	P14.5s	13.2	68	1550	250/450	P.71
64150CBI	H1	12	55	P14.5s	13.2	68	1550	150/250	P.73
64150ULT	H1	12	55	P14.5s	13.2	68	1550	1200/2000	P.77
64151	H3	12	55	PK22s	13.2	68	1450	400/650	P.79
64151NBU	H3	12	55	PK22s	13.2	68	1450	150/300	P.69
64151CBI	H3	12	55	PK22s	13.2	68	1300	150/250	P.73
64152SB ³⁾	-	12	100	PX14,5s	13.2	93	2600	22.5/50	P.99
64153SB ³⁾	-	12	100	PKX22s	13.2	85	2300	23/50	P.99
64155	H1	24	70	P14.5s	28.0	84	1900	400/650	P.95
64155TSP	H1	24	70	P14.5s	28.0	84	1900	600/1200	P.93
64156	H3	24	70	PK22s	28.0	84	1750	400/650	P.95
64156TSP	H3	24	70	PK22s	28.0	max. 84	1750	600/1200	P.73
64173	H2	12	55	X511	13.2	68	1800	90/250	P.79
64175	H2	24	70	X511	28.0	84	2150	90/250	P.95
64176	H15	12	55/15	PGJ23t-1	13.2	19/64	260/1350	2000/250//4000/500	P.79
64176CBI	H15	12	55/15	PGJ23t-1	13.2	max. 19/64	260/1350	1000/100//2000/200	P.73
64177	H15	24	20/60	PGJ23t-1	28.0	max.84	300/1500	1500/200//3000/400	P.95
64183	R2	12	45/40	P45t	13.2	48.5/46.5	1030/740	250/400//500/1200	P.79
64185	HS1	12	35/35	PX43t	13.2	36.8/36.8	820/520	75/150//150/300	P.79
64185NR5	HS1	12	35/35	PX43t	13.2	36.8/36.8	820/520	75/120//120/240	P.87

Product Reference	ECE	V	W		V _{Test}	W _{in}	lm	T _h _{B3/Tc} 1)	
64185NR9	HS1	12	35/35	PX43t	13.2	35/35	825/525	75/120//120/240	P.85
64185XR	HS1	12	35/35	PX43t	13.2	35/35	825/525	75/120//120/240	P.89
64193	H4	12	60/55	P43t	13.2	75/68	1650/1000	250/400//500/900	P.79
64193NBL	H4	12	60/55	P43t	13.2	75/68	1650/1000	80/300//300/500	P.67
64193NBU	H4	12	60/55	P43t	13.2	75/68	1650/1000	300/500	P.69
64193SV2	H4	12	60/55	P43t	13.2	75/68	1650/1000	250/400//450/700	P.71
64193CBI	H4	12	60/55	P43t	13.2	75/68	1650/1000	50/200//100/400	P.73
64193ULT	H4	12	60/55	P43t	13.2	75/68	1650/1000	300/2000//700/3000	P.77
64193NR1	H4	12	60/55	P43t	13.2	75/68	1650/1000	80/260//160/400	P.85
64193NR5	H4	12	60/55	P43t	13.2	75/68	1650/1000	250/400//450/700	P.87
64193XR	H4	12	60/55	P43t	13.2	75/68	1650/1000	50/180//100/380	P.89
64194SB ³⁾	-	12	100/90	PU43t	13.2	109/85	2900/1500	45/85//85/170	P.99
64196	H4	24	75/70	P43t	28.0	85/80	1900/1200	170/350//400/800	P.95
64196TSP	H4	24	75/70	P43t	28.0	85/80	1900/1200	140/450//300/1000	P.93
64198SB ³⁾	-	12	60/55	P45t	13.2	75/68	1650/1000	250/400//500/900	P.99
64204SB ³⁾	-	12	100/90	P45t	13.2	99/88	2200/1500	150/300	P.99
64210	H7	12	55	PX26d	13.2	58	1500	330/550	P.79
64210NBL	H7	12	55	PX26d	13.2	58	1500	150/250	P.67
64210NBU	H7	12	55	PX26d	13.2	58	1500	150/250	P.69
64210SV2	H7	12	55	PX26d	13.2	58	1500	250/450	P.71
64210CBI	H7	12	55	PX26d	13.2	58	1500	100/200	P.73
64210ULT	H7	12	55	PX26d	13.2	58	1500	1000/1500	P.77
64210NR1	H7	12	55	PX26d	13.2	58	1500	150/250	P.85
64210NR5	H7	12	55	PX26d	13.2	58	1500	250/450	P.87
64210XR	H7	12	55	PX26d	13.2	58	1500	100/200	P.89
64211	H11	12	55	PGJ19-2	13.2	62	1350	350/580	P.79
64211NBU	H11	12	55	PGJ19-2	13.2	62	1350	150/250	P.69
64211SV2	H11	12	55	PGJ19-2	13.2	62	1350	250/450	P.71
64211CBI	H11	12	55	PGJ19-2	13.2	62	1350	100/200	P.73
64211ULT	H11	12	55	PGJ19-2	13.2	62	1350	1000/2000	P.77
64211NR1	H11	12	55	PGJ19-2	13.2	62	1350	150/250	P.85
64211NR5	H11	12	55	PGJ19-2	13.2	62	1350	250/450	P.87
64211XR	H11	12	55	PGJ19-2	13.2	62	1350	100/200	P.89
64212	H8	12	35	PGJ19-1	13.2	43	800	400/800	P.79
64212NBU	H8	12	35	PGJ19-1	13.2	max. 43	800	250/500	P.69
64212CBI	H8	12	35	PGJ19-1	13.2	43	800	250/500	P.73
64212XR	H8	12	35	PGJ19-1	13.2	43	800	250/500	P.89
64213	H9	12	65	PGJ19-5	13.2	73	2100	250/500	P.79
64215	H7	24	70	PX26d	28.0	75	1750	220/500	P.95
64215TSP	H7	24	70	PX26d	28.0	75	1750	500/1000	P.93
64216TSP	H11	24	70	PGJ19-2	28.0	max. 80	1600	500/1000	P.93
64219CBI	H16	12	19	PGJ19-3	13.2	max. 26	500	250/500	P.73
64219L+	H16	12	19	PGJ19-3	13.2	26	500	1115/2000	P.79
64241	H11B	12	55	PGJY19-2	13.2	62	1350	350/580	P.79
64242	H8B	12	35	PGJY19-1	13.2	43	800	400/800	P.79
64243	H9B	12	65	PGJY19-5	13.2	73	2100	250/500	P.79
64326	S1	12	25/25	BA20d	13.5	25/25	430/310	-	P.89
64327	S2	12	35/35	BA20d	13.5	35/35	650/460	80/160	P.89
64327XR	S2	12	35/35	BA20d	13.5	35/35	650/465	75/150//120/300	P.89
66140	D1S	85	35	PK32d-2	13.5	35	3200	2000/3000	P.63

Product Reference	ECE	V	W		V _{Test}	W _{in}	lm	T[h] B3/Tc ¹⁾	
66140XNB	D1S	85	35	PK32d-2	13.5	35	3200	1500/3000	P.57
66140CBI	D1S	85	35	PK32d-2	13.5	35	3200	1500/3000	P.73
66140ULT	D1S	85	35	PK32d-2	13.5	35	3200	-	P.61
66140CBB ³⁾	-	85	35	PK32d-2	13.2	35	3200	600/1500	P.101
66150	D1R	85	35	PK32d-3	13.5	35	2800	2000/3000	P.63
66150CBI	D1R	85	35	PK32d-3	13.5	35	2800	1500/3000	P.59
66220CW	-	12	13	PGJ19	12	13	730	-	P.29
66240	D2S	85	35	P32d-2	13.5	35	3200	2000/3000	P.63
66240XNB	D2S	85	35	P32d-2	13.5	35	3200	1500/3000	P.57
66240CBI	D2S	85	35	P32d-2	13.5	35	3200	1800/2800	P.59
66240ULT	D2S	85	35	P32d-2	13.5	35	3200	-	P.61
66240CBB ³⁾	-	85	35	P32d-2	13.2	35	3200	600/1500	P.101
66250	D2R	85	35	P32d-3	13.5	35	2800	2000/3000	P.63
66250CBI	D2R	85	35	P32d-3	13.5	35	2800	1500/2000	P.59
66340	D3S	42	35	PK32d-5	13.5	35	3200	2000/4000	P.63
66340XNB	D3S	42	35	PK32d-5	13.5	35	3200	2000/3000	P.57
66340CBI	D3S	42	35	PK32d-5	13.5	35	3200	2000/3000	P.59
66340ULT	D3S	42	35	PK32d-5	13.5	35	3200	-	P.61
66340CBB ³⁾	-	85	35	PK32d-5	13.2	35	3200	-	P.101
66350	D3R	42	35	PK32d-6	13.5	35	2800	2000/3000	P.63
66440	D4S	42	35	P32d-5	13.5	35	3200	2000/4000	P.63
66440XNB	D4S	42	35	P32d-5	13.5	35	3200	2000/3000	P.57
66440CBI	D4S	42	35	P32d-5	13.5	35	3200	2000/3000	P.59
66440ULT	D4S	42	35	P32d-5	13.5	35	3200	-	P.61
66440CBB ³⁾	-	85	35	P32d-5	13.2	35	3200	-	P.101
66450	D4R	42	35	P32d-6	13.5	35	2800	2000/3000	P.63
66548	D8S	42	25	PK32d-1	13.5	25	2000	2500/4000	P.63
69005SBP ³⁾	-	12	100	P20d	13.2	100	2885	280/550	P.99
69005CBB ³⁾	-	12	100	P20d	13.2	100	1100	350/700	P.101
69006SBP ³⁾	-	12	80	P22d	13.2	max. 80	1890	600/1200	P.99
69006CBB ³⁾	-	12	80	P22d	13.2	80	900	300/600	P.101
94196	H4	24	75/70	P43t	28.0	85/80	1900/1200	170/500//400/1500	P.95
LEDCBCTRL101	-	12	5	-	-	-	-	-	P.35
LEDCBCTRL102	-	12	21	-	-	-	-	-	P.35
LEDCBCTRL103	-	12	50	-	-	-	-	-	P.35
LEDDL102	-	12	15	-	14.0	15	300	5000	P.23
LEDDL301CL15	-	12	13.5	-	14.0	13.5	300	5000	P.23
LEDEXT101	-	12	-	-	-	-	-	-	P.37
LEDEXT102-03	-	12	60	P20d	-	-	-	-	P.37
LEDEXT102-04	-	12	51	P22d	-	-	-	-	P.37
LEDEXT102-10	-	12	42	PY20d	-	-	-	-	P.37
LEDFOG101	-	12/24	7/10	-	14.0/28.0	FOG 7/DRL 10	-	0/5000	P.25
LEDFOG101-TY-M	-	-	-	-	-	-	-	0/5000	P.25
LEDFOG101-VW-M	-	-	-	-	-	-	-	0/5000	P.25
LEDFOG101-NIS-M	-	-	-	-	-	-	-	0/5000	P.25
LEDFOG101-INF-M	-	-	-	-	-	-	-	0/5000	P.25
LEDFOG103-SR	-	12	4x2/12x2	-	14	FOG 4/DRL 12	-	0/5000	P.27
LEDFOG103-GD	-	12	4x2/12x2	-	14	FOG 4/DRL 12	-	0/5000	P.27
LEDFOG103-BL	-	12	4x2/12x2	-	14	FOG 4/DRL 12	-	0/5000	P.27
LEDFOG201	-	12	8	-	14.0	8	-	0/5000	P.27

Product Reference	ECE	V	W		V Test	W In	Im	T[h] B3/Tc 1)	
FOG103/201-TY-M -	-	-	-	-	-	-	-	-	P.27
FOG103/201-VW-M -	-	-	-	-	-	-	-	-	P.27
FOG103/201-NIS-M -	-	-	-	-	-	-	-	-	P.27
LEDHL102-BK -	12	70	-	-	-	-	-	-	P.21
LEDHL102-BK RHD -	12	70	-	-	-	-	-	-	P.21
LEDHL102-CM -	12	70	-	-	-	-	-	-	P.21
LEDHL102-GTI -	12	70	-	-	-	-	-	-	P.21
LEDIL103 -	3.4	3.5	-	-	-	-	280	6000	P.43
LEDIL104 -	220	13-15	-	-	90-250	13-15	1.400	-	P.43
LEDIL105 -	3.4	3.5	-	-	3.7	0.5	150/35	-	P.43
LEDIL106 -	3.4	3.5	-	-	3.7	0.5	150	-	P.43
LEDIL107 -	3.4	3.5	-	-	3.7	1	280/70	-	P.43
LEDIL201 -	4.5	1.5	-	-	-	-	80/25	5000	P.47
LEDIL202 -	4.5	1.6	-	-	-	-	125/90	5000	P.47
LEDIL203 -	4.5	1.5	-	-	-	-	80	5000	P.47
LEDIL204 -	3.7	0.5	-	-	-	-	160/75	6500	P.47
LEDIL205 -	3.6	0.5	-	-	-	-	15	6500	P.47
LEDIL206 -	3.7	3	-	-	-	-	250/30	6500	P.47
LEDIL207 -	3.7	3	-	-	-	-	150/70	6500	P.47
LEDIL209 -	4.5	3	-	-	-	-	300/60	6500	P.47
LEDINT201 -	12	-	-	-	-	-	-	-	P.39
LEDINT202 -	12	-	-	-	-	-	-	-	P.39
LEDINT201-SEC -	12	-	-	-	-	-	-	-	P.39
LEDINT203 -	12	-	-	-	-	-	-	-	P.39
LEDINT102 -	12	-	-	-	-	-	-	-	P.37
LEDINT103 -	12	-	-	-	-	-	-	-	P.37
LEDINT104 -	12	-	-	-	-	-	-	-	P.37
LEDL101 -	3	1.7	-	-	-	-	-	-	P.49
LEDL302 -	4.5	0.5	-	-	-	-	-	-	P.49
ONYX L-7 -	12/24	0.5	-	-	-	0.5	20	-	P.51
ONYX M-7 -	12/24	0.5	-	-	-	0.5	20	-	P.51

1) What do B3 and Tc mean in connection with the service life of bulbs? If we consider the service lives of products that are designed to last a certain time, we can see that they all have identical or similar failure characteristics. If we plot the service lives of the individual bulbs on special logarithmic graph paper, the graph produced is called a “Weibull distribution curve”. In a stable production process we obtain a straight line for the service life via which we can read off various life values. For its products in the automotive sector, OSRAM specifies a B3 value, which indicates the time at which 3% of the tested bulbs have failed. OSRAM also specifies the Tc value (characteristic Weibull value), which indicates the time at which 63.2% of the bulbs have failed. Formerly, only the average value was specified (the average life), which in this system would correspond to a B50 value (i.e. the time at which 50% of the bulbs have failed). By specifying both the B3 value and the Tc value it is possible to get an idea of the spread of the product's service life and hence the quality of the product.

Explanation: single filament lamp e.g. 100/300 | dual filament lamp e.g. $\frac{100}{B_3} / \frac{300}{T_c} / \frac{500}{100}$

- 2) OFF-ROAD only when used in an exterior application. These products do not have ECE approval. This means that they cannot be fitted in exterior lights if the vehicle is to be used on public roads.
- 3) These products do not have ECE approval. This means that they cannot be fitted in “normal” headlights or additional headlights if the vehicle is to be used on public roads.

Regional EAN overview

The new packaging reflects specific regional requirements by offering regionalized variants with a dedicated EAN.

■ Region 1 = WEST-MEA
 ■ Region 2 = CIS
 ■ Region 3 = EASTIC
 ■ Region 4 = LATAM
 ■ Region 5 = EMEA

COUNTRY	REGION LED + VAP Blister, DUO BOX	REGION ORIGINAL Blister	COUNTRY	REGION LED + VAP blister, DUO BOX	REGION ORIGINAL Blister	COUNTRY	REGION LED + VAP blister, DUO BOX	REGION ORIGINAL Blister	COUNTRY	REGION LED + VAP blister, DUO BOX	REGION ORIGINAL Blister
Albania	■	■	Democratic Republic of Congo	■		Lebanon	■	■	São Tomé and Príncipe	■	
Algeria	■	■	Denmark	■	■	Lesotho	■		Saudi Arabia	■	■
Andorra	■		Dominica	■		Liberia	■		Senegal	■	
Angola	■	■	Dominican Republic	■		Libya	■	■	Serbia	■	■
Antigua and Barbuda	■		Gabon	■		Liechtenstein	■		Seychelles	■	
Equatorial Guinea	■		Gambia	■		Lithuania	■	■	Sierra Leone	■	
Argentina	■		Ghana	■		Macedonia	■	■	Slovakia	■	■
Armenia	■	■	Grenada	■		Madagascar	■		Slovenia	■	■
Austria	■	■	Georgia	■	■	Malawi	■		Somalia	■	
Azerbaijan	■	■	Germany	■	■	Mali	■		South Africa	■	■
Bahamas	■		Greece	■	■	Malta	■		South Sudan	■	
Bahrain	■	■	Guatemala	■		Mauretania	■		Spain	■	■
Barbados	■		Guinea	■		Mauritius	■		Sudan	■	
Belarus	■	■	Guinea-Bissau	■		Monaco	■		Suriname	■	
Belize	■		Guyana	■		Morocco	■	■	Swaziland	■	
Benelux (Belgium, Netherlands, Luxembourg)	■	■	Haiti	■		Mexico	■	■	Sweden	■	■
Benin	■		Honduras	■		Moldavia	■	■	Switzerland	■	■
Bolivia	■		Djibouti	■		Monte Negro	■	■	Syria	■	■
Bosnia and Herzegovina	■	■	Ecuador	■		Mosambique	■	■	Tajikistan	■	
Botswana	■	■	El Salvador	■		Namibia	■	■	Tanzania	■	■
Brazil	■		Egypt	■	■	Nicaragua	■		Togo	■	
Bulgaria	■	■	Eritrea	■		Niger	■		Trinidad and Tobago	■	
Burkina Faso	■		Estonia	■	■	Nigeria	■	■	Tunisia	■	■
Burundi	■		Ethiopia	■	■	Norway	■	■	Turkey	■	■
Cameroon	■		Finland	■	■	Oman	■	■	Uganda	■	
Cape Verde	■		France	■	■	Pakistan	■	■	Ukraine	■	■
Central African Rep.	■		Hungary	■	■	Palestine	■	■	UK/Ireland	■	■
Chad	■		Iceland	■		Panama	■		Ukraine	■	■
Chile	■		Iran	■	■	Paraguay	■		United Arab Emirates	■	■
Comoros	■		Iraq	■	■	Peru	■	■	Uruguay	■	
Congo	■		Israel	■	■	Poland	■	■	Uzbekistan/	■	■
Colombia	■		Italy	■	■	Portugal	■	■	Turkmenistan	■	
Costa Rica	■		Jamaica	■		Qatar	■	■	Vatican City	■	
Côte d'Ivoire	■		Jordan	■	■	Romania	■	■	Venezuela	■	■
Croatia	■	■	Kazakhstan/	■	■	Rwanda	■		Yemen	■	■
Czechia	■	■	Kirgistan	■		Russia	■	■	Zambia	■	
Cuba	■		Kenya	■	■	Saint Kitts and Nevis	■		Zimbabwe	■	■
Cyprus	■		Kosovo	■	■	Saint Lucia	■				
			Kuwait	■	■	Saint Vincenta and the Grenadines	■				
			Latvia	■	■	San Marino	■				

Product Reference	Region 1 = WEST-MEA	Region 2 = CIS	Region 3 = EASTIC	Region 4 = LATAM	Region 5 = EMEA
66140XNB-HCB	4052899429833	4052899429857	4052899429871	-	-
66240XNB-HCB	4052899429956	4052899429970	4052899430013	-	-
66340XNB-HCB	4052899430051	4052899430112	4052899430150	-	-
66440XNB-HCB	4052899430211	4052899430235	4052899430259	-	-
66140CBI-HCB	4052899431577	4052899431621	4052899431645	-	-
66240CBI-HCB	4052899431683	4052899431706	4052899431720	-	-
66340CBI-HCB	4052899431768	4052899431782	4052899431812	-	-
66440CBI-HCB	4052899431850	4052899431874	4052899431898	-	-
66140ULT-HCB	4052899429598	4052899429611	4052899429635	-	-
66240ULT-HCB	4052899429659	4052899429673	4052899429697	-	-

Product Reference	Region 1 = WEST-MEA	Region 2 = CIS	Region 3 = EASTIC	Region 4 = LATAM	Region 5 = EMEA
66340ULT-HCB	4052899429710	4052899429734	4052899429758	-	-
66440ULT-HCB	4052899429772	4052899429796	4052899429819	-	-
66140CBB-HCB	4052899439184	4052899439207	4052899439221	-	-
66240CBB-HCB	4052899441026	4052899441040	4052899441064	-	-
66340CBB-HCB	4052899527560	4052899527584	-	-	-
66440CBB-HCB	4052899527522	4052899527546	-	-	-
64193NBL-01B	4052899436831	4052899436916	4052899436879	4052899436794	-
64193NBL-HCB	4052899436619	4052899436756	4052899436718	4052899436497	-
64210NBL-01B	4052899436817	4052899436893	4052899436855	4052899436770	-
64210NBL-HCB	4052899436596	4052899436732	4052899436633	4052899436459	-
64150NBU-01B	4052899016781	4052899411623	4052899411661	4052899411586	-
64150NBU-HCB	4052899016286	4052899413269	4052899413368	4052899413160	-
64151NBU-01B	4052899016729	4052899411647	4052899411685	4052899411609	-
64193NBU-01B	4052899017177	4052899410954	4052899411012	4052899410893	-
64193NBU-HCB	4052899017214	4052899413283	4052899413382	4052899413184	-
64210NBU-01B	4052899017047	4052899410930	4052899410992	4052899410879	-
64210NBU-HCB	4052899017061	4052899413245	4052899413344	4052899413146	-
64212NBU-HCB	4052899290181	4052899413306	4052899413405	4052899413207	-
64211NBU-01B	4052899016804	4052899410978	4052899411036	4052899410916	-
64211NBU-HCB	4052899277533	4052899413320	4052899413429	4052899413221	-
9005NBU-HCB	4052899030756	4052899413603	4052899413689	4052899413528	-
9006NBU-HCB	4052899030817	4052899413627	4052899413702	4052899413542	-
64150SV2-01B	4008321785855	4052899428577	4052899428591	-	-
64150SV2-HCB	4008321785893	4052899428751	4052899428782	4052899428690	-
64193SV2-01B	4008321785961	4052899428522	4052899428508	-	-
64193SV2-HCB	4008321786005	4052899428881	4052899428904	4052899428867	-
64210SV2-01B	4008321786715	4052899428485	4052899428546	-	-
64210SV2-HCB	4008321786753	4052899428652	4052899428676	4052899428638	-
64211SV2-HCB	4008321787187	4052899428829	4052899428843	4052899428805	-
64150CBI-01B	4008321655424	4052899411418	4052899411432	4052899411395	-
64150CBI-HCB	4008321650719	4052899412880	4052899412965	4052899412804	-
64193CBI-01B	4008321651280	4052899410794	4052899410817	4052899410718	-
64193CBI-HCB	4008321650733	4052899413061	4052899413108	-	-
64210CBI-01B	4008321651563	4052899410831	4052899410855	-	-
64210CBI-HCB	4008321650757	4052899413047	4052899413085	-	-
64212CBI-HCB	4052899931077	4052899412903	4052899412989	4052899412828	-
64211CBI-HCB	4008321650771	4052899412927	4052899413009	4052899412842	-
64176CBI-HCB	4052899982208	4052899982192	4052899982185	-	-
64219CBI-HCB	4052899268357	4052899412941	4052899413023	4052899412866	-
9005CBI-HCB	4008321660282	4052899413641	4052899413726	4052899413566	-
9006CBI-HCB	4008321660305	4052899413665	4052899413740	4052899413580	-
2825HCB-02B	4008321650870	4052899418646	4052899418660	4052899418622	-
2827DC-02B	4008321972750	4052899417939	4052899417953	4052899417915	-
7507DC-02B	4008321972774	4052899417991	4052899418011	4052899417977	-
7507LDA-02B	4050300925486	4052899418707	4052899418721	4052899418684	-
7508LDR-01B	4008321376848	4052899418516	4052899418530	4052899418493	-
7538LDR-01B	4008321376862	4052899418578	4052899418592	4052899418554	-
64150ULT-01B	4008321416100	4052899412156	4052899412170	-	-
64150ULT-HCB	4008321416162	4052899425163	4052899425187	4052899987043	-
64193ULT-01B	4008321416124	4052899425125	4052899425149	-	-
64193ULT-HCB	4008321416186	4052899425200	4052899425224	4052899513198	-

Product Reference	Region 1 = WEST-MEA	Region 2 = CIS	Region 3 = EASTIC	Region 4 = LATAM	Region 5 = EMEA
64210ULT-01B	4052899436534	4052899436152	4052899436237	-	-
64210ULT-HCB	4052899436558	4052899436213	4052899436251	4052899513211	-
64211ULT-01B	4052899436473	4052899436114	4052899436176	-	-
64211ULT-HCB	4052899436510	4052899436138	4052899436190	-	-
7506ULT-02B	4008321415141	4052899419469	4052899419483	-	-
7507ULT-02B	4008321415165	4052899419506	4052899419520	-	-
7528ULT-02B	4008321415288	4052899419582	4052899419605	-	-
2825ULT-02B	4008321415189	4052899419322	4052899419346	-	-
5007ULT-02B	4008321415202	4052899419308	4052899419384	-	-
5008ULT-02B	4008321415226	4052899419421	4052899419445	-	-
6418ULT-02B	4008321415240	4052899419629	4052899419643	-	-
64132ULT-02B	4008321415325	4052899419667	4052899419681	-	-
64150-01B	-	-	-	4052899412026	4050300925264
64151-01B	-	-	-	4052899412040	4050300925349
64193-01B	-	-	-	4052899411869	4050300925127
64210-01B	-	-	-	4052899411821	4050300925202
64210-01B	-	-	-	4052899408173	4050300925202
64212-01B	-	-	-	4052899411906	4052899262478
64211-01B	-	-	-	4052899411920	4008321171252
9005-01B	-	-	-	4052899408562	4008321171214
9006-01B	-	-	-	4052899408975	4008321171238
64183-01B	-	-	-	4052899411944	4050300925400
7506-02B	-	-	-	4052899402034	4050300925448
7507-02B	-	-	-	4052899531178	4050300925462
7225-02B	-	-	-	4052899402119	4050300925547
7528-02B	-	-	-	4052899402171	4050300925523
3893-02B	-	-	-	4052899407381	4050300647609
2821-02B	-	-	-	4052899418813	4050300925745
2825-02B	-	-	-	4052899418837	4050300925684
2827-02B	-	-	-	4052899417854	4008321149411
921-02B	-	-	-	4052899406933	4008321349507
7505-02B	-	-	-	4052899417878	4052899324565
7515-02B	-	-	-	4052899417892	4052899324589
2721-02B	-	-	-	4052899418790	4050300925769
2722-02B	-	-	-	4052899407251	4050300925783
5007-02B	-	-	-	4052899407015	4050300925585
5008-02B	-	-	-	4052899407176	4050300925608
6411-02B	-	-	-	4052899418936	4050300925646
64111-02B	-	-	-	-	4050300647258
6418-02B	-	-	-	4052899418950	4050300925622
6438-02B	-	-	-	-	4008321185389
64193NR1-01B	4052899929654	4052899411227	4052899411104	4052899411166	-
64210NR1-01B	4052899929593	4052899411203	4052899411081	4052899411142	-
64212NR1-01B	4052899389403	4052899451285	4052899451308	-	-
64211NR1-01B	4052899253728	4052899411241	4052899411128	4052899411180	-
64185NR9-01B	4052899253452	4052899408302	4052899408326	-	-
64193NR5-01B	4052899929524	4052899411289	4052899411340	-	-
64210NR5-01B	4052899929470	4052899411265	4052899411326	-	-
64211NR5-01B	4052899253742	4052899411302	4052899411364	-	-
64185NR5-01B	4052899929425	4052899984318	4052899984332	-	-
64193XR-01B	4052899253681	4052899412385	4052899412460	4052899412224	-

Product Reference	Region 1 = WEST-MEA	Region 2 = CIS	Region 3 = EASTIC	Region 4 = LATAM	Region 5 = EMEA
64210XR-01B	4052899253704	4052899412309	4052899412446	4052899412200	-
64211XR-01B	4052899936591	4052899412422	4052899412507	4052899412262	-
64212XR-01B	4052899253667	4052899412408	4052899412484	4052899412248	-
64185XR-01B	4052899253490	4052899408371	4052899408395	4052899408357	-
64327XR-01B	4052899936607	4052899409613	4052899409637	4052899409590	-
64327-01B	-	-	-	4052899409576	4052899929692
64185-01B	-	-	-	4052899408418	4052899253513
64155TSP-HCB	4008321784209	4052899413931	4052899414037	4052899413832	-
64156TSP-01B	4052899481930	4052899481916	4052899481893	4052899481954	-
64196TSP-HCB	4008321785077	4052899413979	4052899414075	4052899413870	-
64215TSP-HCB	4008321785145	4052899413917	4052899414013	4052899413818	-
64216TSP-HCB	4052899904644	4052899413993	4052899414099	4052899413894	-
3930TSP-02B	4008321174055	-	-	-	-
64155-01B	-	-	-	4052899412101	4050300925844
64156-01B	-	-	-	4052899412125	4050300565811
64196-01B	-	-	-	4052899411883	4050300925868
64215-01B	-	-	-	4052899411845	4050300925882
7511-02B	-	-	-	-	4050300925929
7537-02B	-	-	-	4052899402232	4050300925943
5627-02B	-	-	-	4052899418882	4050300925967
5637-02B	-	-	-	-	4050300926049
3930-02B	-	-	-	-	4050300926001
2841-02B	-	-	-	4052899407275	4050300926025
2845-02B	-	-	-	4052899407329	4008321139962
6423-02B	-	-	-	-	4050300925981
62150CBB-HCB	4052899439764	4052899437678	4052899436930	4052899439009	-
62193CBB-HCB	4052899439788	4052899437654	4052899437296	4052899439023	-
62210CBB-HCB	4052899439801	4052899437692	4052899437371	4052899439047	-
62211CBB-HCB	4052899439849	4052899437715	4052899437395	4052899439085	-
62213CBB-HCB	4052899439863	4052899437739	4052899437487	4052899439108	-
69005CBB-HCB	4052899439887	4052899437753	4052899437524	4052899439122	-
69006CBB-HCB	4052899439900	4052899437777	4052899437548	4052899439146	-
1557CW-02B	4052899367975	4052899433854	4052899433878	-	-
1557R-02B	4052899368026	4052899433915	4052899433939	-	-
1557YE-02B	4052899368002	4052899433977	4052899433991	-	-
2850CW-02B	4008321657657	4052899434424	4052899434448	4052899434400	-
2850WW-02B	4008321657633	4052899434493	4052899434516	4052899434479	-
2850BL-02B	4008321875549	4052899434356	4052899434370	4052899434332	-
2855YE-02B	4008321875600	4052899434592	4052899434615	4052899434578	-
3557CW-02B	4052899368040	4052899434882	4052899434905	-	-
3557R-02B	4052899368088	4052899434943	4052899434967	-	-
3557YE-02B	4052899368064	4052899435001	4052899435025	-	-
3850WW-02B	4008321657893	4052899440531	4052899440579	4052899440517	-
3850CW-02B	4008321658111	4052899440623	4052899440661	4052899440609	-
6497WW-01B	4052899068445	4052899435452	4052899435490	4052899435414	-

Product Reference	Region 1 = WEST-MEA	Region 2 = CIS	Region 3 = EASTIC	Region 4 = LATAM	Region 5 = EMEA
6497CW-01B	4052899068469	4052899435377	4052899435391	4052899435353	-
6498WW-01B	4008321658159	4052899436015	4052899436039	4052899435995	-
6498CW-01B	4008321658173	4052899442207	4052899442221	4052899442184	-
6499WW-01B	4052899068506	4052899442276	4052899442313	4052899442252	-
6499CW-01B	4052899068483	4052899436077	4052899436091	4052899436053	-
7556CW-02B	4052899367760	4052899441484	4052899441507	-	-
7556R-02B	4052899367944	4052899441545	4052899441569	-	-
7556YE-02B	4052899367906	4052899441668	4052899441743	-	-
7557YE-02B	4052899368101	4052899441781	4052899441804	-	-
7905CW-02B	4052899359475	4052899442399	4052899442412	-	-
7905R-02B	4052899359512	4052899442436	4052899442450	-	-
7905YE-02B	4052899359499	4052899442474	4052899442498	-	-
7915CW-02B	4052899359550	4052899442511	4052899442535	-	-
7915R-02B	4052899359598	4052899442559	4052899442573	-	-
7915YE-02B	4052899359574	4052899442597	4052899442610	-	-
9213CW-02B	4052899381896	4052899443020	4052899443044	-	-
9213R-02B	4052899381933	4052899443082	4052899443105	-	-
2824WW-02B	4008321875624	4052899434288	4052899434301	4052899434264	-
2824CW-02B	4008321875648	4052899434219	4052899434233	4052899434189	-
3924CW-02B	4008321875747	4052899440739	4052899440753	4052899440715	-
3924WW-02B	4008321875723	4052899440845	4052899440869	4052899440807	-
1457CW-02B	4052899358010	4052899434035	4052899434059	-	-
1457R-02B	4052899358058	4052899434073	4052899434097	-	-
1457YE-02B	4052899358034	4052899434110	4052899434134	-	-
2880BL-02B	4052899359314	4052899434653	4052899434677	-	-
2880CW-02B	4052899067820	4052899434707	4052899434721	-	-
2880YE-02B	4052899385597	4052899434820	4052899434844	-	-
2880GR-02B	4052899385634	4052899434745	4052899434769	-	-
2880R-02B	4052899359338	4052899434783	4052899434806	-	-
3547CW-02B	4052899385702	4052899435124	4052899435148	-	-
3547R-02B	4052899385726	4052899435179	4052899435193	-	-
3547YE-02B	4052899385740	4052899435223	4052899435247	-	-
6431CW-01B	4052899358072	4052899441286	4052899441309	4052899414792	-
6431BL-01B	4052899358133	4052899441248	4052899441262	-	-
6436CW-01B	4052899358096	4052899445567	4052899445581	4052899414778	-
6436BL-01B	4052899358157	4052899441323	4052899441347	-	-
6441CW-01B	4052899358119	4052899441422	4052899441446	4052899414815	-
6441BL-01B	4052899358171	4052899441378	4052899441408	-	-
7456CW-02B	4052899357938	4052899441903	4052899441927	-	-
7456R-02B	4052899357976	4052899441965	4052899441989	-	-
7456YE-02B	4052899357952	4052899442023	4052899442047	-	-
7457YE-02B	4052899357990	4052899442061	4052899442085	-	-
7705CW-02B	4052899359413	4052899442757	4052899442771	-	-
7705R-02B	4052899359451	4052899442795	4052899442818	-	-
7705YE-02B	4052899359437	4052899442832	4052899442856	-	-
7715CW-02B	4052899359536	4052899442870	4052899442894	-	-
7715R-02B	4052899361003	4052899442917	4052899442931	-	-
7715YE-02B	4052899362147	4052899442955	4052899442979	-	-
9212CW-02B	4052899474444	4052899474482	4052899474468	-	-
Counter Display NBL	4052899981584	4052899981577	-	-	-

Low beam/full beam 

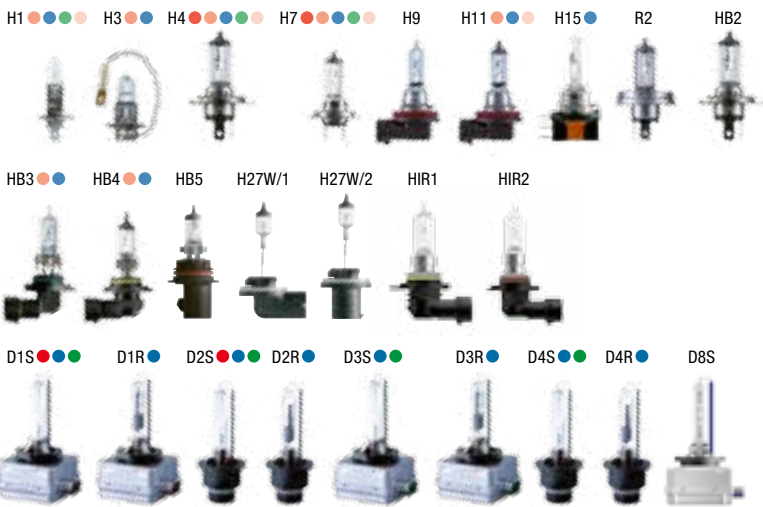

Fog light 

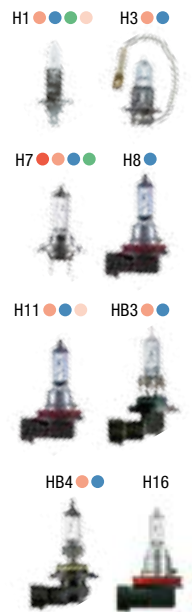

Side indicator 



Front indicator 



Parking/marker light 



UPGRADE

HALOGEN LIGHTING

- **NIGHT BREAKER® LASER (page 66)**
 - Up to 130% more light on the road¹⁾
- **NIGHT BREAKER® UNLIMITED (page 68)**
 - Up to 110% more light on the road¹⁾
- **SILVERSTAR® 2.0 (page 70)**
 - Up to 60% more light on the road¹⁾

- **COOL BLUE® INTENSE (page 72)**
 - Bluish-white light for xenon look
- **DIADEM® CHROME (page 74)**
 - Only amber when operating, otherwise almost invisible
- **DIADEM® (page 74)**
 - Lamps with amber or red light emission

Brake light 

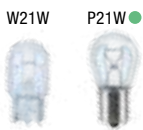

Brake light/tail light  



Tail light 



Reversing light 



Rear indicator 



Number plate light 



Rear fog light 



- **ULTRA LIFE (page 76)**
- Up to 4 times longer service life¹⁾

1) Compared with standard lamps
 2) When compared to standard xenon lamps
 3) 10-year guarantee requires online registration of new purchases.
 Refer to www.osram.com/am-guarantee for precise conditions and registration

XENON LIGHTING

- **XENARC® NIGHT BREAKER® UNLIMITED (page 56)**
- Up to 70% more light on the road²⁾
- **XENARC® COOL BLUE® INTENSE (page 58)**
- Color temperatures up to 5,500 K
- **XENARC® ULTRA LIFE (page 60)**
- Ten-year guarantee³⁾

Parking/marker light 

W5W ● C5W R5W ● T4W ●



Indicator 

P21W ● PY21W ● H21W



Fog light 

H1 ● H3 ● H7 ●



Side-marker light 

W5W ● W3W T4W ● R5W ● C5W



Number plate light 

W5W ● T4W ● R5W ● C5W



Low beam/full beam  

H1 ● H3 ● H4 ● H7 ● H15



D1S ● D1R ● D2S ● D2R ●



D3S ● D3R ● D4S ● D4R ● D8S



Parking/marker light 

W3W ● W5W ● T4W ● R5W ● R10W ●



Indicator, brake, rear fog and reversing light lamps



P21W ● P21/5W ● H21W ● PY21W ● W5W ●



UPGRADE

HALOGEN LIGHTING

- **TRUCKSTAR® PRO** (page 92)
- Up to 110% more light¹⁾

XENON LIGHTING

- **XENARC® NIGHT BREAKER® UNLIMITED** (page 56)
- Up to 70% more light on the road²⁾
- **XENARC® COOL BLUE® INTENSE** (page 58)
- Color temperatures up to 5,500 K
- **XENARC® ULTRA LIFE** (page 60)
- Ten-year guarantee³⁾

1) Compared with standard lamps

Low beam/full beam

H4 H7 H8 H11 S1 S2 HS1

Front indicator

R5W R10W RY10W P21W

PY21W WY5W

Reversing/brake light

P21/5W R5W

Rear indicator

R5W R10W RY10W WY5W

P21W PY21W

Number plate light

H6W R5W C5W

HALOGEN LIGHTING

- NIGHT RACER® 110 (page 84)**
— Up to 110% more light on the road¹⁾
- NIGHT RACER® 90 (page 84)**
— Up to 90% more light on the road¹⁾
- NIGHT RACER® 50 (page 86)**
— Up to 50% more light¹⁾

- X-RACER® (page 88)**
— Bluish-white light for xenon look
- DIADEM® CHROME (page 74)**
— Only amber when operating, otherwise almost invisible

- DIADEM® (page 74)**
— Lamps with amber or red light emission
- ULTRA LIFE (page 76)**
— Up to 4 times longer service life¹⁾

Dome light front 

C5W SV8.5-8 ● T4W BA9s ● W5W W2.1x9.5d ●



Glovebox 

C5W SV8.5-8 ● T4W BA9s ● W5W W2.1x9.5d ●



Engine compartment light 

C5W SV8.5-8 ● W5W W2.1x9.5d ●



Legroom 

C5W SV8.5-8 ● W5W W2.1x9.5d ●



Reading lamp front 

C5W SV8.5-8 ● T4W BA9s ● W5W W2.1x9.5d ●



Make-up mirror 

C5W SV8.5-8 ● W5W W2.1x9.5d ●



Door lamp 

C5W SV8.5-8 ● W5W W2.1x9.5d ●



Dome light behind 

C5W SV8.5-8 ● T4W BA9s ● W5W W2.1x9.5d ●



Reading lamp behind 

C5W SV8.5-8 ● T4W BA9s ● W5W W2.1x9.5d ●



Trunk lamp 

C5W SV8.5-8 ● T4W BA9s ● W5W W2.1x9.5d ●

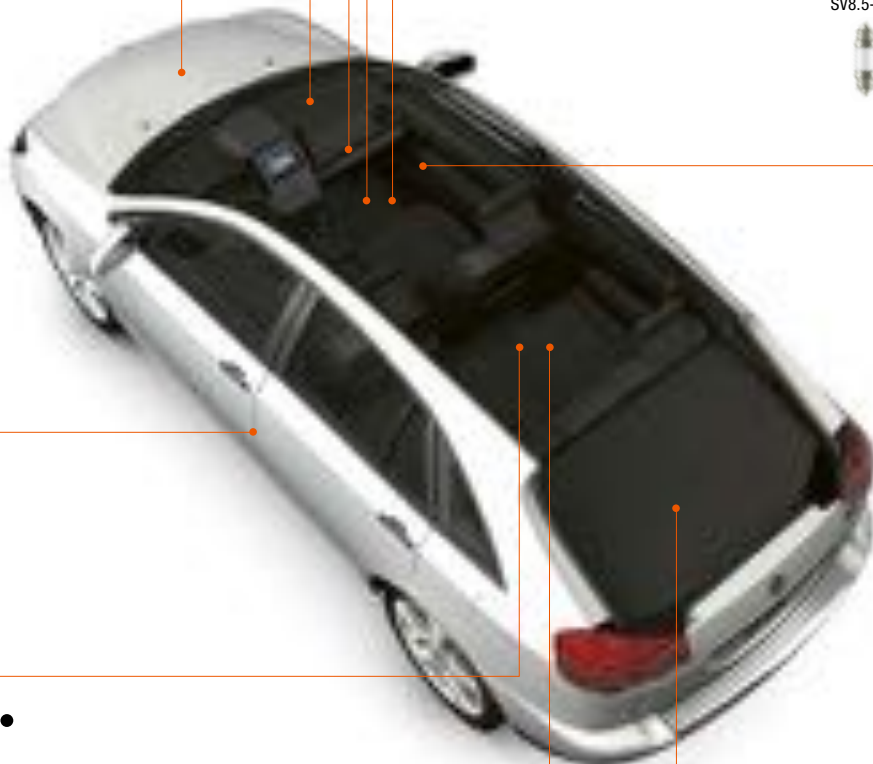

UPGRADE

LED LIGHTING

● **LED Retrofits (page 28-35)**

— Perfect LED light thanks to state-of-the-art diffuser material¹⁾

¹⁾ INTERIOR ONLY. These products do not have ECE approval. This means they must not be fitted in any exterior automotive application.



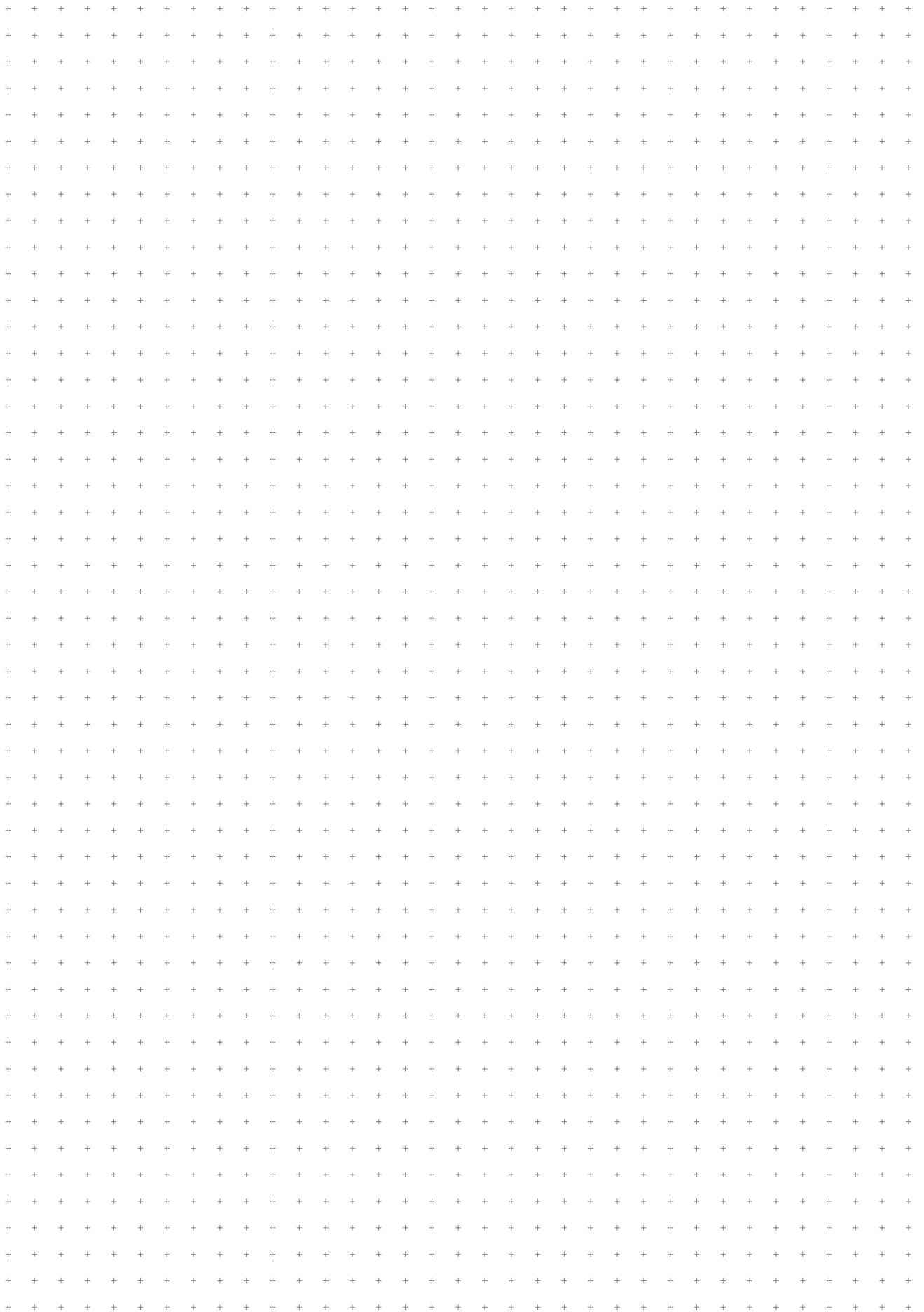



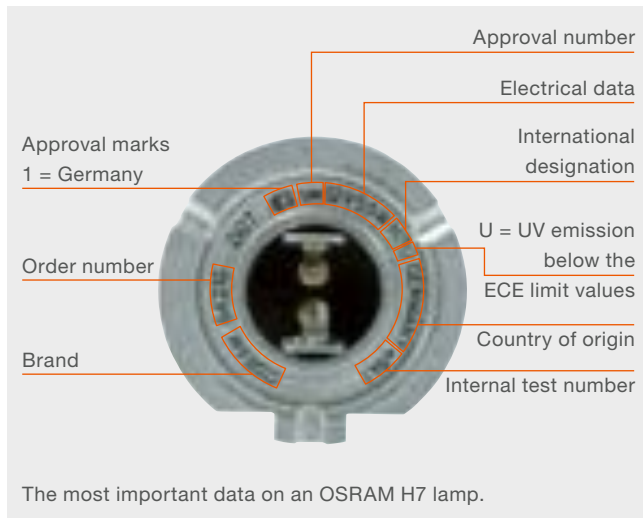



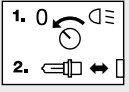

INTERIOR ONLY!



Base stamp

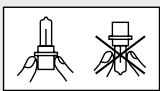

Notes on product labeling

	Not for residential lighting		Do not dispose with household waste
	High levels of UV radiation		1. 0 Switch off lights before replacing lamp 2. [Symbol] →
	Installation and maintenance only by qualified electricians		Ignition procedure for lamps with external igniter
	Caution: hot		Lamp cannot be dimmed
	Hazardous voltage		Wear suitable gloves when fitting or removing
	Do not use the lamp if the glass bulb is scratched or damaged		Protect against splashes
	Wear suitable goggles when fitting or removing		Operate only in shielded luminaires
	Do not touch the glass bulb; hold the base when inserting		

Lamps per Product number



Any manipulation of our products or packaging, including but not limited to modification, reworking or restamping, is prohibited and infringes our registered trademark rights. Such modifications may impair the technical properties of our products, destroy them or cause consequential damage or injury, for which OSRAM cannot under any circumstances be held responsible. For more information on our products, go to: www.osram.com

Glossary of the most important lighting terms

Luminous flux Φ

Unit of measurement: lumen [lm]

Luminous flux Φ is the total radiated power emitted by a light source evaluated with the spectral sensitivity of the eye and the photometric radiation equivalent K_m .

Luminous flux Φ is the luminous intensity I emitted in the entire solid angle Ω .

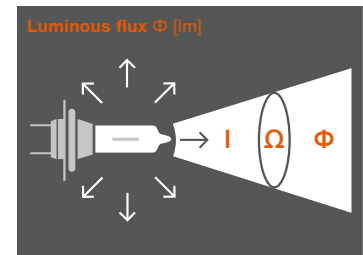

Luminous intensity I

Unit of measurement: candela [cd]

Generally speaking, a light source emits its luminous flux Φ in different directions and at different intensities.

Luminous intensity is the luminous flux radiated in a specific direction (solid angle Ω).

Polar diagram.

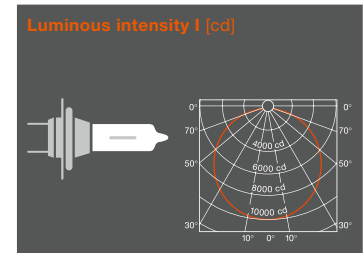

Illuminance E

Unit of measurement: lux [lx]

Illuminance E is the ratio between the luminous flux and the area illuminated. An illuminance of 1 lx occurs when a luminous flux of 1 lm is evenly distributed over an area of 1 m².

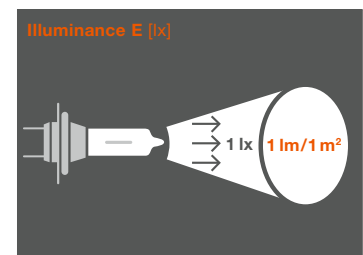

Luminance L

Unit of measurement: candela per square meter [cd/m²]

The luminance L of a light source or an illuminated area is a measure of the impression of brightness.

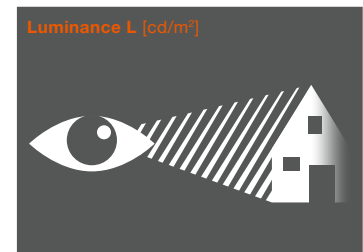

Luminous efficacy η

Unit of measurement: lumens per watt [lm/W]

Luminous efficacy η indicates the efficiency with which the electrical power consumed is converted into light.

Color temperature

Unit of measurement: Kelvin [K]









The color temperature of a light source is defined in comparison with a "black body radiator" and plotted on what is known as the "Planckian curve." The higher the temperature of this black body radiator the greater the blue component in the spectrum and the smaller the red component.

Lamp life

The B_3 life-span value represents the premature failure rate of lamps. This means that 3% of all tested lamps will have failed after this number of burning hours.

The T_c lifespan value represents the failure rate of 63.2% of the lamps.

Symbols

ECE	Int. category label ECE
W	Rated wattage in watts
W_{In}	Power consumption in watts
V	Voltage in volts
V_{Test}	Test voltage in volts
lm	Luminous flux in lumens
T[h] B3/Tc	Lifespan (h)
lx	Illuminance in lux
λ [nm]	Wavelength (λ)
K	Color temperature in K
COLOR	Light color
T_C	Time (h) after failure of 63.2 % of lamps
B₃	Time (h) after failure of 3% of lamps
i	Information
	Battery
	Base
	Fig. no.
	Weight
	Width b in mm
	Height h in mm
	Length l in mm
	Shipping unit
	Single packaging

Packaging variants

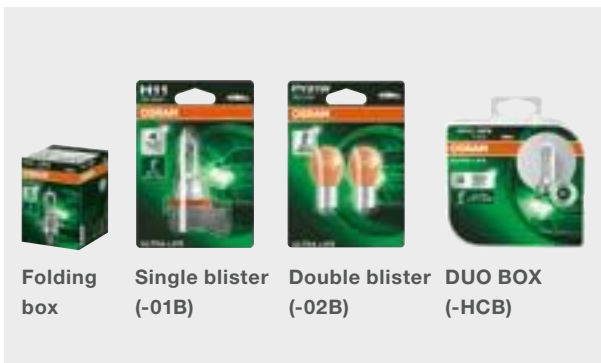

Always up to date!
Download the latest OSRAM
Automotive catalog here:

www.osram.com/am-catalog



Which lamps fit your vehicle?
Find out with our Vehicle Lamp Finder
online app:

www.osram.com/vehiclelamps



Stay up to date!
Follow OSRAM Automotive on Facebook:

www.facebook.com/osramautomotive

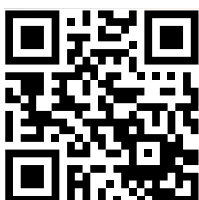

Read about events, tests and technology
insights on our all new OSRAM Carlightblog:

www.carlightblog.com



OSRAM

OSRAM is the world market leader in automotive lighting. Our customers include the world's foremost automobile manufacturers. Half of all passenger vehicles manufactured globally each year are equipped with OSRAM lights.

OSRAM SITES

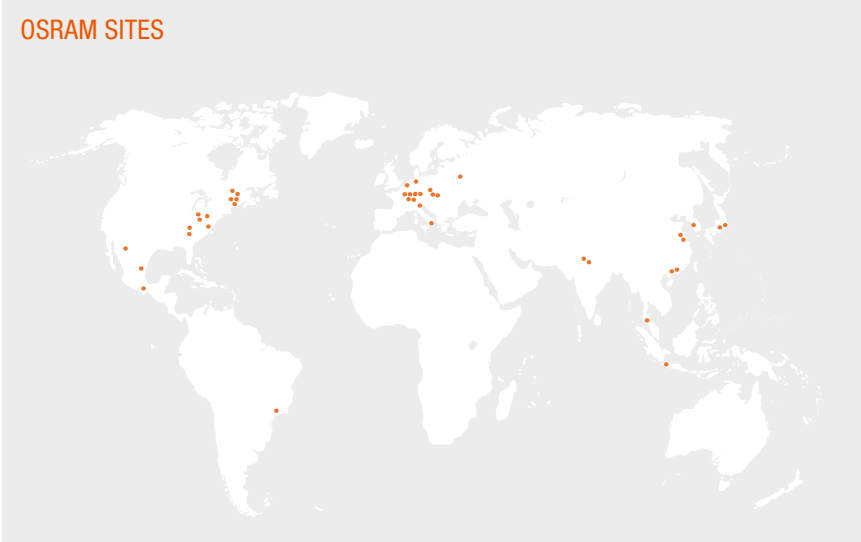

Light range 2017/2018 – always up-to-date

Download the pdf of our current catalog that's constantly updated. www.osram.com/am-catalog



OSRAM GmbH

Head office:

Marcel-Breuer-Strasse 6
80807 Munich, Germany
Phone +49 89 6213-0
Fax +49 89 6213-2020
www.osram.com

OSRAM